

SWISSDIS



Swissdis AG
Grasweg 7
CH-4911 Schwarzhäusern

Tel.: +41 62 919 44 00
Fax: +41 62 919 44 01
info@swissdis.ch
www.swissdis.ch



SPECIFICATIONS

General Purpose / Standard MLCC

Cxx up to 50V

Version October 2022

Structure

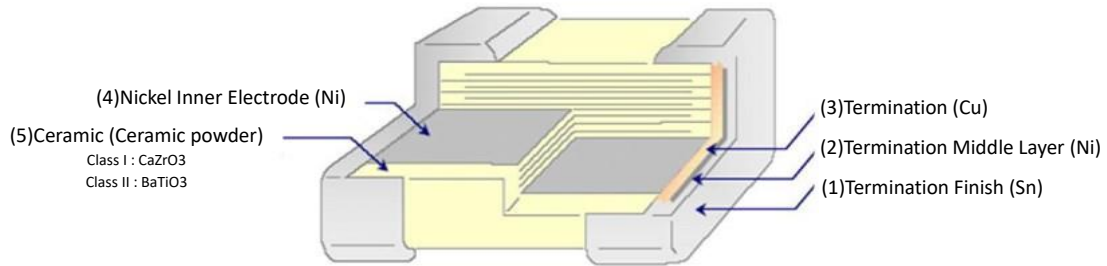

Ordering Code

C 1005 NP0 101 J G T S Δ

PRODUCT CODE

C = MLCC

SIZE in mm (EIA CODE, in inch)

0402(01005) 0603(0201) 1005 (0402) 1608 (0603) 2012 (0805)
 3216 (1206) 3225(1210) 4520 (1808) 4532 (1812)

T. C.

X8R:±15%	-55°C to +150°C
NP0: 0 ± 30ppm/°C	-55°C to +125°C
X7R: ±15% X7S:±22% X7T: +22%/-33% X7U: +22%/-56%	-55°C to +105°C
X6S: ±22% X6T: +22%/-33%	-55°C to +85°C
X5R: ±15%	

CAPACITANCE CODE

Expressed in pico-farads and identified by a three-digit number.

First two digits represent significant figures.

Last digit specifies the number of zeros.

(Use 9 for 1.0 through 9.9pF ; Use 8 for 0.20 through 0.99pF)

Example:

Code	478	229	101	102
Cap (pF)	0.47	2.2	100	1000

TOLERANCE CODE

A: ± 0.05pF B: ± 0.1pF C: ± 0.25pF D: ± 0.5pF F: ±1% G: ±2%
 J: ±5% K: ±10% M: ±20%

VOLTAGE CODE

T: 2.5V B: 4V C: 6.3V D: 10V E: 16V F: 25V N: 35V G: 50V H: 100V
 J: 200V K: 250V L: 500V M: 630V P: 1KV Q: 2KV R: 3KV S: 4KV

PACKAGING CODE

T: Paper tape reel Ø180mm (7") P: Embossed tape reel Ø180mm (7")
 N: Paper tape reel Ø250mm (10") D: Embossed tape reel Ø250mm (10")
 A: Paper tape reel Ø330mm (13") E: Embossed tape reel Ø330mm (13")
 W: Special Packing

Application Code

S: Standard Q: High Q/Low ESR F: Microwave A: Automotive Infotainment with AEC-Q200

Thickness Code

Code	Thick (mm)	Code	Thick(mm)	Code	Thick (mm)	Code	Thick (mm)
(blank)	Standard Thick	M	0.70	G	1.25	S	1.90
Z	0.20	D	0.80	H	1.50	--	--
A	0.30	E	0.85	L	1.60	--	--
Q	0.45	I	0.95	N	2.00	--	--
B	0.50	J	1.00	P	2.50	--	--
C	0.60	F	1.15	R	3.20	--	--

General Purpose

■ Standard External Dimensions

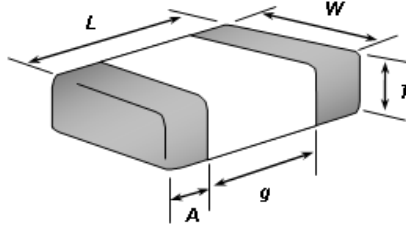

TYPE		Dimension (mm)				
Size (EIA Size)	Kind	L (Length)	W (Width)	T (Max.)	g (Min)	A (Min/Max)
C0603 (0201)	Standard	0.6 ± 0.03	0.30 ± 0.03	0.33	0.15	0.10 / 0.20
	Special (1)	0.6 ± 0.05	0.30 ± 0.05	0.35		
	Special (2)	0.6 ± 0.09	0.30 ± 0.09	0.39		0.10 / 0.25
C1005 (0402)	Standard	1.0 ± 0.05	0.50 ± 0.05	0.55	0.30	0.15 / 0.35
	Special (1)	1.0 ± 0.10	0.50 ± 0.10	0.60		
	Special (2)	1.0 ± 0.15	0.50 ± 0.15	0.65		
	Special (3)	1.0 ± 0.20	0.50 ± 0.20	0.70		
	Special (4)	1.0 ± 0.30	0.50 ± 0.30	0.80		
C1608 (0603)	Standard	1.6 ± 0.10	0.80 ± 0.10	0.90	0.50	0.25 / 0.65
	Special (1)	1.6 ± 0.15	0.80 ± 0.15	0.95		
	Special (2)	1.6 ± 0.20	0.80 ± 0.20	1.00		
	Special (3)	1.6 ± 0.25	0.80 ± 0.25	1.05		
C2012 (0805)	Standard	2.0 ± 0.15	1.25 ± 0.15	1.45	0.70	0.25 / 0.75
	Special (1)	2.0 ± 0.20	1.25 ± 0.20	1.45		
C3216 (1206)	Standard	3.2 ± 0.15	1.60 ± 0.15	1.80	1.50	0.25 / 0.75
	Special (1)	3.2 ± 0.20	1.60 ± 0.20	1.90		
	Special (2)	3.2 ± 0.30	1.60 ± 0.30	1.90		
C3225 (1210)	Standard	3.2 ± 0.30	2.50 ± 0.20	2.80	1.50	0.3 / 0.90
	Special (1)	3.2 ± 0.30	2.50 ± 0.30	2.80		

For special parts, please see the "Part Number & Characteristic" for detail specification.

● **Class I: Temperature Compensating Type**

■ **Feature**

1. Ultra-stable
2. Tight tolerance available
3. Low ESR (Frequency is within 800MHz)
4. Good frequency performance
5. No aging of capacitance
6. RoHS compliant
7. Halogen Free

■ **Application**

1. LC and RC tuned circuit
2. Filtering
3. Timing

■ **Part Number & Characteristic**

■ NP0 Series

● C0603NP0 Series (EIA0201)

RV	DARFON P/N	DARFON P/N 2	Measuring Condition	Capacitance		Available Tolerance	Thick. (mm)	Tolerance(mm)		DF (max.)	Standard Packing
				Value	Unit			L/W	Thick.		
50V	C0603NP0208□GTS	C0603NP0208□GT	1V, 1MHz	0.20	pF	±0.25pF,±0.1pF,±0.05pF	0.30	±0.03	±0.03	0.25%	Paper,15Kpcs
	C0603NP0308□GTS	C0603NP0308□GT	1V, 1MHz	0.30	pF	±0.25pF,±0.1pF,±0.05pF	0.30	±0.03	±0.03	0.25%	
	C0603NP0408□GTS	C0603NP0408□GT	1V, 1MHz	0.40	pF	±0.25pF,±0.1pF,±0.05pF	0.30	±0.03	±0.03	0.25%	
	C0603NP0508□GTS	C0603NP0508□GT	1V, 1MHz	0.50	pF	±0.25pF,±0.1pF,±0.05pF	0.30	±0.03	±0.03	0.24%	
	C0603NP0608□GTS	C0603NP0608□GT	1V, 1MHz	0.60	pF	±0.25pF,±0.1pF,±0.05pF	0.30	±0.03	±0.03	0.24%	
	C0603NP0708□GTS	C0603NP0708□GT	1V, 1MHz	0.70	pF	±0.25pF,±0.1pF,±0.05pF	0.30	±0.03	±0.03	0.24%	
	C0603NP0758□GTS	C0603NP0758□GT	1V, 1MHz	0.75	pF	±0.25pF,±0.1pF,±0.05pF	0.30	±0.03	±0.03	0.24%	
	C0603NP0808□GTS	C0603NP0808□GT	1V, 1MHz	0.80	pF	±0.25pF,±0.1pF,±0.05pF	0.30	±0.03	±0.03	0.24%	
	C0603NP0908□GTS	C0603NP0908□GT	1V, 1MHz	0.90	pF	±0.25pF,±0.1pF,±0.05pF	0.30	±0.03	±0.03	0.24%	
	C0603NP0109□GTS	C0603NP0109□GT	1V, 1MHz	1.0	pF	±0.25pF,±0.1pF,±0.05pF	0.30	±0.03	±0.03	0.24%	
	C0603NP0119□GTS	C0603NP0119□GT	1V, 1MHz	1.1	pF	±0.25pF,±0.1pF	0.30	±0.03	±0.03	0.24%	
	C0603NP0129□GTS	C0603NP0129□GT	1V, 1MHz	1.2	pF	±0.25pF,±0.1pF	0.30	±0.03	±0.03	0.24%	
	C0603NP0139□GTS	C0603NP0139□GT	1V, 1MHz	1.3	pF	±0.25pF,±0.1pF	0.30	±0.03	±0.03	0.23%	
	C0603NP0159□GTS	C0603NP0159□GT	1V, 1MHz	1.5	pF	±0.25pF,±0.1pF	0.30	±0.03	±0.03	0.23%	
	C0603NP0169□GTS	C0603NP0169□GT	1V, 1MHz	1.6	pF	±0.25pF,±0.1pF	0.30	±0.03	±0.03	0.23%	
	C0603NP0189□GTS	C0603NP0189□GT	1V, 1MHz	1.8	pF	±0.25pF,±0.1pF	0.30	±0.03	±0.03	0.23%	
	C0603NP0209□GTS	C0603NP0209□GT	1V, 1MHz	2.0	pF	±0.25pF,±0.1pF	0.30	±0.03	±0.03	0.23%	
	C0603NP0229□GTS	C0603NP0229□GT	1V, 1MHz	2.2	pF	±0.25pF,±0.1pF	0.30	±0.03	±0.03	0.23%	
	C0603NP0249□GTS	C0603NP0249□GT	1V, 1MHz	2.4	pF	±0.25pF,±0.1pF	0.30	±0.03	±0.03	0.22%	
	C0603NP0279□GTS	C0603NP0279□GT	1V, 1MHz	2.7	pF	±0.25pF,±0.1pF	0.30	±0.03	±0.03	0.22%	
	C0603NP0309□GTS	C0603NP0309□GT	1V, 1MHz	3.0	pF	±0.25pF,±0.1pF	0.30	±0.03	±0.03	0.22%	
	C0603NP0339□GTS	C0603NP0339□GT	1V, 1MHz	3.3	pF	±0.25pF,±0.1pF	0.30	±0.03	±0.03	0.21%	
	C0603NP0359□GTS	C0603NP0359□GT	1V, 1MHz	3.5	pF	±0.25pF,±0.1pF	0.30	±0.03	±0.03	0.21%	
	C0603NP0369□GTS	C0603NP0369□GT	1V, 1MHz	3.6	pF	±0.25pF,±0.1pF	0.30	±0.03	±0.03	0.21%	
	C0603NP0399□GTS	C0603NP0399□GT	1V, 1MHz	3.9	pF	±0.25pF,±0.1pF	0.30	±0.03	±0.03	0.21%	
	C0603NP0409□GTS	C0603NP0409□GT	1V, 1MHz	4.0	pF	±0.25pF,±0.1pF	0.30	±0.03	±0.03	0.21%	
	C0603NP0439□GTS	C0603NP0439□GT	1V, 1MHz	4.3	pF	±0.25pF,±0.1pF	0.30	±0.03	±0.03	0.21%	
	C0603NP0479□GTS	C0603NP0479□GT	1V, 1MHz	4.7	pF	±0.25pF,±0.1pF	0.30	±0.03	±0.03	0.20%	
	C0603NP0509□GTS	C0603NP0509□GT	1V, 1MHz	5.0	pF	±0.5pF,±0.25pF,±0.1pF	0.30	±0.03	±0.03	0.20%	
	C0603NP0519□GTS	C0603NP0519□GT	1V, 1MHz	5.1	pF	±0.5pF,±0.25pF,±0.1pF	0.30	±0.03	±0.03	0.20%	
	C0603NP0569□GTS	C0603NP0569□GT	1V, 1MHz	5.6	pF	±0.5pF,±0.25pF,±0.1pF	0.30	±0.03	±0.03	0.20%	
	C0603NP0609□GTS	C0603NP0609□GT	1V, 1MHz	6.0	pF	±0.5pF,±0.25pF,±0.1pF	0.30	±0.03	±0.03	0.19%	
	C0603NP0629□GTS	C0603NP0629□GT	1V, 1MHz	6.2	pF	±0.5pF,±0.25pF,±0.1pF	0.30	±0.03	±0.03	0.19%	
	C0603NP0689□GTS	C0603NP0689□GT	1V, 1MHz	6.8	pF	±0.5pF,±0.25pF,±0.1pF	0.30	±0.03	±0.03	0.19%	
	C0603NP0709□GTS	C0603NP0709□GT	1V, 1MHz	7.0	pF	±0.5pF,±0.25pF,±0.1pF	0.30	±0.03	±0.03	0.19%	
	C0603NP0759□GTS	C0603NP0759□GT	1V, 1MHz	7.5	pF	±0.5pF,±0.25pF,±0.1pF	0.30	±0.03	±0.03	0.18%	
	C0603NP0809□GTS	C0603NP0809□GT	1V, 1MHz	8.0	pF	±0.5pF,±0.25pF,±0.1pF	0.30	±0.03	±0.03	0.18%	
	C0603NP0829□GTS	C0603NP0829□GT	1V, 1MHz	8.2	pF	±0.5pF,±0.25pF,±0.1pF	0.30	±0.03	±0.03	0.18%	
	C0603NP0909□GTS	C0603NP0909□GT	1V, 1MHz	9.0	pF	±0.5pF,±0.25pF,±0.1pF	0.30	±0.03	±0.03	0.17%	
	C0603NP0919□GTS	C0603NP0919□GT	1V, 1MHz	9.1	pF	±0.5pF,±0.25pF,±0.1pF	0.30	±0.03	±0.03	0.17%	
C0603NP0100□GTS	C0603NP0100□GT	1V, 1MHz	10	pF	±5%,±2%,±1%	0.30	±0.03	±0.03	0.17%		
C0603NP0120□GTS	C0603NP0120□GT	1V, 1MHz	12	pF	±5%,±2%,±1%	0.30	±0.03	±0.03	0.16%		
C0603NP0150□GTS	C0603NP0150□GT	1V, 1MHz	15	pF	±5%,±2%,±1%	0.30	±0.03	±0.03	0.14%		
C0603NP0180□GTS	C0603NP0180□GT	1V, 1MHz	18	pF	±5%,±2%,±1%	0.30	±0.03	±0.03	0.13%		
C0603NP0200□GTS	C0603NP0200□GT	1V, 1MHz	20	pF	±5%,±2%,±1%	0.30	±0.03	±0.03	0.13%		
C0603NP0220□GTS	C0603NP0220□GT	1V, 1MHz	22	pF	±5%,±2%,±1%	0.30	±0.03	±0.03	0.12%		
C0603NP0240JGTS	C0603NP0240JGT	1V, 1MHz	24	pF	±5%	0.30	±0.03	±0.03	0.11%		

RV	DARFON P/N	DARFON P/N 2	Measuring Condition	Capacitance		Available Tolerance	Thick. (mm)	Tolerance(mm)		DF (max.)	Standard Packing
				Value	Unit			L/W	Thick.		
50V	C0603NP0270□GTS	C0603NP0270□GT	1V, 1MHz	27	pF	±5%,±2%,±1%	0.30	±0.03	±0.03	0.11%	Paper,15Kpcs
	C0603NP0300□GTS	C0603NP0300□GT	1V, 1MHz	30	pF	±5%,±2%,±1%	0.30	±0.03	±0.03	0.10%	
	C0603NP0330□GTS	C0603NP0330□GT	1V, 1MHz	33	pF	±5%,±2%,±1%	0.30	±0.03	±0.03	0.10%	
	C0603NP0360□GTS	C0603NP0360□GT	1V, 1MHz	36	pF	±5%,±2%	0.30	±0.03	±0.03	0.10%	
	C0603NP0390□GTS	C0603NP0390□GT	1V, 1MHz	39	pF	±5%,±2%,±1%	0.30	±0.03	±0.03	0.10%	
	C0603NP0430JGTS	C0603NP0430JGT	1V, 1MHz	43	pF	±5%	0.30	±0.03	±0.03	0.10%	
	C0603NP0470□GTS	C0603NP0470□GT	1V, 1MHz	47	pF	±5%,±2%,±1%	0.30	±0.03	±0.03	0.10%	
	C0603NP0510□GTS	C0603NP0510□GT	1V, 1MHz	51	pF	±5%,±2%	0.30	±0.03	±0.03	0.10%	
	C0603NP0560□GTS	C0603NP0560□GT	1V, 1MHz	56	pF	±5%,±2%,±1%	0.30	±0.03	±0.03	0.10%	
	C0603NP0620□GTS	C0603NP0620□GT	1V, 1MHz	62	pF	±5%,±2%	0.30	±0.03	±0.03	0.10%	
	C0603NP0680□GTS	C0603NP0680□GT	1V, 1MHz	68	pF	±5%,±2%,±1%	0.30	±0.03	±0.03	0.10%	
	C0603NP0750□GTS	C0603NP0750□GT	1V, 1MHz	75	pF	±5%,±2%	0.30	±0.03	±0.03	0.10%	
	C0603NP0820□GTS	C0603NP0820□GT	1V, 1MHz	82	pF	±5%,±2%,±1%	0.30	±0.03	±0.03	0.10%	
	C0603NP0101□GTS	C0603NP0101□GT	1V, 1MHz	100	pF	±5%,±2%,±1%	0.30	±0.03	±0.03	0.10%	
	C0603NP0121□GTS	C0603NP0121□GT	1V, 1MHz	120	pF	±5%,±2%	0.30	±0.03	±0.03	0.10%	
	C0603NP0151□GTS	C0603NP0151□GT	1V, 1MHz	150	pF	±5%,±2%,±1%	0.30	±0.03	±0.03	0.10%	
	C0603NP0181□GTS	C0603NP0181□GT	1V, 1MHz	180	pF	±5%,±2%,±1%	0.30	±0.03	±0.03	0.10%	
	C0603NP0201JGTS	C0603NP0201JGT	1V, 1MHz	200	pF	±5%	0.30	±0.03	±0.03	0.10%	
	C0603NP0221□GTS	C0603NP0221□GT	1V, 1MHz	220	pF	±5%,±2%	0.30	±0.03	±0.03	0.10%	
	C0603NP0271JGTS	C0603NP0271JGT	1V, 1MHz	270	pF	±5%	0.30	±0.03	±0.03	0.10%	
C0603NP0331JGTS	C0603NP0331JGT	1V, 1MHz	330	pF	±5%	0.30	±0.03	±0.03	0.10%		
C0603NP0391JGTS	C0603NP0391JGT	1V, 1MHz	390	pF	±5%	0.30	±0.03	±0.03	0.10%		
C0603NP0471JGTS	C0603NP0471JGT	1V, 1MHz	470	pF	±5%	0.30	±0.03	±0.03	0.10%		
25V	C0603NP0208□FTS	C0603NP0208□FT	1V, 1MHz	0.20	pF	±0.25pF,±0.1pF,±0.05pF	0.30	±0.03	±0.03	0.25%	Paper,15Kpcs
	C0603NP0308□FTS	C0603NP0308□FT	1V, 1MHz	0.30	pF	±0.25pF,±0.1pF,±0.05pF	0.30	±0.03	±0.03	0.25%	
	C0603NP0408□FTS	C0603NP0408□FT	1V, 1MHz	0.40	pF	±0.25pF,±0.1pF,±0.05pF	0.30	±0.03	±0.03	0.25%	
	C0603NP0508□FTS	C0603NP0508□FT	1V, 1MHz	0.50	pF	±0.25pF,±0.1pF,±0.05pF	0.30	±0.03	±0.03	0.24%	
	C0603NP0608□FTS	C0603NP0608□FT	1V, 1MHz	0.60	pF	±0.25pF,±0.1pF,±0.05pF	0.30	±0.03	±0.03	0.24%	
	C0603NP0708□FTS	C0603NP0708□FT	1V, 1MHz	0.70	pF	±0.25pF,±0.1pF,±0.05pF	0.30	±0.03	±0.03	0.24%	
	C0603NP0758□FTS	C0603NP0758□FT	1V, 1MHz	0.75	pF	±0.25pF,±0.1pF,±0.05pF	0.30	±0.03	±0.03	0.24%	
	C0603NP0808□FTS	C0603NP0808□FT	1V, 1MHz	0.80	pF	±0.25pF,±0.1pF,±0.05pF	0.30	±0.03	±0.03	0.24%	
	C0603NP0908□FTS	C0603NP0908□FT	1V, 1MHz	0.90	pF	±0.25pF,±0.1pF,±0.05pF	0.30	±0.03	±0.03	0.24%	
	C0603NP0109□FTS	C0603NP0109□FT	1V, 1MHz	1.0	pF	±0.25pF,±0.1pF,±0.05pF	0.30	±0.03	±0.03	0.24%	
	C0603NP0129□FTS	C0603NP0129□FT	1V, 1MHz	1.2	pF	±0.25pF,±0.1pF	0.30	±0.03	±0.03	0.24%	
	C0603NP0139□FTS	C0603NP0139□FT	1V, 1MHz	1.3	pF	±0.25pF,±0.1pF	0.30	±0.03	±0.03	0.23%	
	C0603NP0149□FTS	C0603NP0149□FT	1V, 1MHz	1.4	pF	±0.25pF,±0.1pF	0.30	±0.03	±0.03	0.23%	
	C0603NP0159□FTS	C0603NP0159□FT	1V, 1MHz	1.5	pF	±0.25pF,±0.1pF	0.30	±0.03	±0.03	0.23%	
	C0603NP0169□FTS	C0603NP0169□FT	1V, 1MHz	1.6	pF	±0.25pF,±0.1pF	0.30	±0.03	±0.03	0.23%	
	C0603NP0179□FTS	C0603NP0179□FT	1V, 1MHz	1.7	pF	±0.25pF,±0.1pF	0.30	±0.03	±0.03	0.23%	
	C0603NP0189□FTS	C0603NP0189□FT	1V, 1MHz	1.8	pF	±0.25pF,±0.1pF	0.30	±0.03	±0.03	0.23%	
	C0603NP0199□FTS	C0603NP0199□FT	1V, 1MHz	1.9	pF	±0.25pF,±0.1pF	0.30	±0.03	±0.03	0.23%	
	C0603NP0209□FTS	C0603NP0209□FT	1V, 1MHz	2.0	pF	±0.25pF,±0.1pF	0.30	±0.03	±0.03	0.23%	
	C0603NP0229□FTS	C0603NP0229□FT	1V, 1MHz	2.2	pF	±0.25pF,±0.1pF	0.30	±0.03	±0.03	0.23%	
	C0603NP0249□FTS	C0603NP0249□FT	1V, 1MHz	2.4	pF	±0.25pF,±0.1pF	0.30	±0.03	±0.03	0.22%	
	C0603NP0279□FTS	C0603NP0279□FT	1V, 1MHz	2.7	pF	±0.25pF,±0.1pF	0.30	±0.03	±0.03	0.22%	
	C0603NP0309□FTS	C0603NP0309□FT	1V, 1MHz	3.0	pF	±0.25pF,±0.1pF	0.30	±0.03	±0.03	0.22%	
	C0603NP0339□FTS	C0603NP0339□FT	1V, 1MHz	3.3	pF	±0.25pF,±0.1pF	0.30	±0.03	±0.03	0.21%	
	C0603NP0359□FTS	C0603NP0359□FT	1V, 1MHz	3.5	pF	±0.25pF,±0.1pF	0.30	±0.03	±0.03	0.21%	
	C0603NP0369□FTS	C0603NP0369□FT	1V, 1MHz	3.6	pF	±0.25pF,±0.1pF	0.30	±0.03	±0.03	0.21%	
	C0603NP0399□FTS	C0603NP0399□FT	1V, 1MHz	3.9	pF	±0.25pF,±0.1pF	0.30	±0.03	±0.03	0.21%	
	C0603NP0409□FTS	C0603NP0409□FT	1V, 1MHz	4.0	pF	±0.25pF,±0.1pF	0.30	±0.03	±0.03	0.21%	
	C0603NP0439□FTS	C0603NP0439□FT	1V, 1MHz	4.3	pF	±0.25pF,±0.1pF	0.30	±0.03	±0.03	0.21%	
	C0603NP0479□FTS	C0603NP0479□FT	1V, 1MHz	4.7	pF	±0.25pF,±0.1pF	0.30	±0.03	±0.03	0.20%	
	C0603NP0509□FTS	C0603NP0509□FT	1V, 1MHz	5.0	pF	±0.5pF,±0.25pF,±0.1pF	0.30	±0.03	±0.03	0.20%	
	C0603NP0519□FTS	C0603NP0519□FT	1V, 1MHz	5.1	pF	±0.5pF,±0.25pF,±0.1pF	0.30	±0.03	±0.03	0.20%	
	C0603NP0569□FTS	C0603NP0569□FT	1V, 1MHz	5.6	pF	±0.5pF,±0.25pF,±0.1pF	0.30	±0.03	±0.03	0.20%	
	C0603NP0609□FTS	C0603NP0609□FT	1V, 1MHz	6.0	pF	±0.5pF,±0.25pF,±0.1pF	0.30	±0.03	±0.03	0.19%	
	C0603NP0629□FTS	C0603NP0629□FT	1V, 1MHz	6.2	pF	±0.5pF,±0.25pF,±0.1pF	0.30	±0.03	±0.03	0.19%	
	C0603NP0689□FTS	C0603NP0689□FT	1V, 1MHz	6.8	pF	±0.5pF,±0.25pF,±0.1pF	0.30	±0.03	±0.03	0.19%	
	C0603NP0709□FTS	C0603NP0709□FT	1V, 1MHz	7.0	pF	±0.5pF,±0.25pF,±0.1pF	0.30	±0.03	±0.03	0.19%	
	C0603NP0759□FTS	C0603NP0759□FT	1V, 1MHz	7.5	pF	±0.5pF,±0.25pF,±0.1pF	0.30	±0.03	±0.03	0.18%	
	C0603NP0809□FTS	C0603NP0809□FT	1V, 1MHz	8.0	pF	±0.5pF,±0.25pF,±0.1pF	0.30	±0.03	±0.03	0.18%	
	C0603NP0829□FTS	C0603NP0829□FT	1V, 1MHz	8.2	pF	±0.5pF,±0.25pF,±0.1pF	0.30	±0.03	±0.03	0.18%	
C0603NP0909□FTS	C0603NP0909□FT	1V, 1MHz	9.0	pF	±0.5pF,±0.25pF,±0.1pF	0.30	±0.03	±0.03	0.17%		
C0603NP0919□FTS	C0603NP0919□FT	1V, 1MHz	9.1	pF	±0.5pF,±0.25pF,±0.1pF	0.30	±0.03	±0.03	0.17%		
C0603NP0100□FTS	C0603NP0100□FT	1V, 1MHz	10	pF	±5%,±2%,±1%	0.30	±0.03	±0.03	0.17%		

RV	DARFON P/N	DARFON P/N 2	Measuring Condition	Capacitance		Available Tolerance	Thick. (mm)	Tolerance(mm)		DF (max.)	Standard Packing
				Value	Unit			L/W	Thick.		
25V	C0603NP0120□FTS	C0603NP0120□FT	1V, 1MHz	12	pF	±5%,±2%,±1%	0.30	±0.03	±0.03	0.16%	Paper, 15Kpcs
	C0603NP0150□FTS	C0603NP0150□FT	1V, 1MHz	15	pF	±5%,±2%,±1%	0.30	±0.03	±0.03	0.14%	
	C0603NP0160□FTS	C0603NP0160□FT	1V, 1MHz	16	pF	±5%,±2%,±1%	0.30	±0.03	±0.03	0.14%	
	C0603NP0180□FTS	C0603NP0180□FT	1V, 1MHz	18	pF	±5%,±2%,±1%	0.30	±0.03	±0.03	0.13%	
	C0603NP0200□FTS	C0603NP0200□FT	1V, 1MHz	20	pF	±5%,±2%,±1%	0.30	±0.03	±0.03	0.13%	
	C0603NP0220□FTS	C0603NP0220□FT	1V, 1MHz	22	pF	±5%,±2%,±1%	0.30	±0.03	±0.03	0.12%	
	C0603NP0240□FTS	C0603NP0240□FT	1V, 1MHz	24	pF	±5%,±2%,±1%	0.30	±0.03	±0.03	0.11%	
	C0603NP0270□FTS	C0603NP0270□FT	1V, 1MHz	27	pF	±5%,±2%,±1%	0.30	±0.03	±0.03	0.11%	
	C0603NP0300□FTS	C0603NP0300□FT	1V, 1MHz	30	pF	±5%,±2%,±1%	0.30	±0.03	±0.03	0.10%	
	C0603NP0330□FTS	C0603NP0330□FT	1V, 1MHz	33	pF	±5%,±2%,±1%	0.30	±0.03	±0.03	0.10%	
	C0603NP0390□FTS	C0603NP0390□FT	1V, 1MHz	39	pF	±5%,±2%,±1%	0.30	±0.03	±0.03	0.10%	
	C0603NP0430JFTS	C0603NP0430JFT	1V, 1MHz	43	pF	±5%	0.30	±0.03	±0.03	0.10%	
	C0603NP0470□FTS	C0603NP0470□FT	1V, 1MHz	47	pF	±5%,±2%,±1%	0.30	±0.03	±0.03	0.10%	
	C0603NP0510JFTS	C0603NP0510JFT	1V, 1MHz	51	pF	±5%	0.30	±0.03	±0.03	0.10%	
	C0603NP0560□FTS	C0603NP0560□FT	1V, 1MHz	56	pF	±5%,±2%,±1%	0.30	±0.03	±0.03	0.10%	
	C0603NP0620JFTS	C0603NP0620JFT	1V, 1MHz	62	pF	±5%	0.30	±0.03	±0.03	0.10%	
	C0603NP0680□FTS	C0603NP0680□FT	1V, 1MHz	68	pF	±5%,±2%,±1%	0.30	±0.03	±0.03	0.10%	
	C0603NP0750JFTS	C0603NP0750JFT	1V, 1MHz	75	pF	±5%	0.30	±0.03	±0.03	0.10%	
	C0603NP0820□FTS	C0603NP0820□FT	1V, 1MHz	82	pF	±5%,±2%,±1%	0.30	±0.03	±0.03	0.10%	
	C0603NP0101□FTS	C0603NP0101□FT	1V, 1MHz	100	pF	±5%,±2%,±1%	0.30	±0.03	±0.03	0.10%	
	C0603NP0121JFTS	C0603NP0121JFT	1V, 1MHz	120	pF	±5%	0.30	±0.03	±0.03	0.10%	
	C0603NP0131JFTS	C0603NP0131JFT	1V, 1MHz	130	pF	±5%	0.30	±0.03	±0.03	0.10%	
	C0603NP0151JFTS	C0603NP0151JFT	1V, 1MHz	150	pF	±5%	0.30	±0.03	±0.03	0.10%	
	C0603NP0181JFTS	C0603NP0181JFT	1V, 1MHz	180	pF	±5%	0.30	±0.03	±0.03	0.10%	
	C0603NP0201JFTS	C0603NP0201JFT	1V, 1MHz	200	pF	±5%	0.30	±0.03	±0.03	0.10%	
	C0603NP0221JFTS	C0603NP0221JFT	1V, 1MHz	220	pF	±5%	0.30	±0.03	±0.03	0.10%	
	C0603NP0241JFTS	C0603NP0241JFT	1V, 1MHz	240	pF	±5%	0.30	±0.03	±0.03	0.10%	
	C0603NP0271JFTS	C0603NP0271JFT	1V, 1MHz	270	pF	±5%	0.30	±0.03	±0.03	0.10%	
	C0603NP0301JFTS	C0603NP0301JFT	1V, 1MHz	300	pF	±5%	0.30	±0.03	±0.03	0.10%	
	C0603NP0331□FTS	C0603NP0331□FT	1V, 1MHz	330	pF	±5%,±2%	0.30	±0.03	±0.03	0.10%	
C0603NP0361JFTS	C0603NP0361JFT	1V, 1MHz	360	pF	±5%	0.30	±0.03	±0.03	0.10%		
C0603NP0391JFTS	C0603NP0391JFT	1V, 1MHz	390	pF	±5%	0.30	±0.03	±0.03	0.10%		
C0603NP0431JFTS	C0603NP0431JFT	1V, 1MHz	430	pF	±5%	0.30	±0.03	±0.03	0.10%		
C0603NP0471□FTS	C0603NP0471□FT	1V, 1MHz	470	pF	±5%,±2%,±1%	0.30	±0.03	±0.03	0.10%		
C0603NP0511JFTS	C0603NP0511JFT	1V, 1MHz	510	pF	±5%	0.30	±0.03	±0.03	0.10%		
C0603NP0621JFTS	C0603NP0621JFT	1V, 1MHz	620	pF	±5%	0.30	±0.03	±0.03	0.10%		
C0603NP0751JFTS	C0603NP0751JFT	1V, 1MHz	750	pF	±5%	0.30	±0.03	±0.03	0.10%		
C0603NP0561JFTS	C0603NP0561JFT	1V, 1MHz	560	pF	±5%	0.30	±0.03	±0.03	0.10%		
C0603NP0681JFTS	C0603NP0681JFT	1V, 1MHz	680	pF	±5%	0.30	±0.03	±0.03	0.10%		
C0603NP0102JFTS	C0603NP0102JFT	1V, 1MHz	1.0	nF	±5%	0.30	±0.03	±0.03	0.10%		
16V	C0603NP0279□ETS	C0603NP0279□ET	1V, 1MHz	2.7	pF	±0.25pF,±0.1pF	0.30	±0.03	±0.03	0.22%	Paper, 15Kpcs
	C0603NP0330□ETS	C0603NP0330□ET	1V, 1MHz	33	pF	±5%,±2%,±1%	0.30	±0.03	±0.03	0.10%	
	C0603NP0201JETS	C0603NP0201JET	1V, 1MHz	200	pF	±5%	0.30	±0.03	±0.03	0.10%	
	C0603NP0221JETS	C0603NP0221JET	1V, 1MHz	220	pF	±5%	0.30	±0.03	±0.03	0.10%	
10V	C0603NP0330□DTS	C0603NP0330□DT	1V, 1MHz	33	pF	±5%,±2%,±1%	0.30	±0.03	±0.03	0.10%	Paper, 15Kpcs

● C1005NP0 Series (EIA0402)

RV	DARFON P/N	DARFON P/N 2	Measuring Condition	Capacitance		Available Tolerance	Thick. (mm)	Tolerance(mm)		DF (max.)	Standard Packing
				Value	Unit			L/W	Thick.		
50V	C1005NP0208□GTS	C1005NP0208□GT	1V, 1MHz	0.20	pF	±0.25pF,±0.1pF,±0.05pF	0.50	±0.05	±0.05	0.25%	Paper, 10Kpcs
	C1005NP0308□GTS	C1005NP0308□GT	1V, 1MHz	0.30	pF	±0.25pF,±0.1pF,±0.05pF	0.50	±0.05	±0.05	0.25%	
	C1005NP0408□GTS	C1005NP0408□GT	1V, 1MHz	0.40	pF	±0.25pF,±0.1pF,±0.05pF	0.50	±0.05	±0.05	0.25%	
	C1005NP0508□GTS	C1005NP0508□GT	1V, 1MHz	0.50	pF	±0.25pF,±0.1pF,±0.05pF	0.50	±0.05	±0.05	0.24%	
	C1005NP0608□GTS	C1005NP0608□GT	1V, 1MHz	0.60	pF	±0.25pF,±0.1pF,±0.05pF	0.50	±0.05	±0.05	0.24%	
	C1005NP0688□GTS	C1005NP0688□GT	1V, 1MHz	0.68	pF	±0.25pF,±0.1pF,±0.05pF	0.50	±0.05	±0.05	0.24%	
	C1005NP0708□GTS	C1005NP0708□GT	1V, 1MHz	0.70	pF	±0.25pF,±0.1pF,±0.05pF	0.50	±0.05	±0.05	0.24%	
	C1005NP0808□GTS	C1005NP0808□GT	1V, 1MHz	0.80	pF	±0.25pF,±0.1pF,±0.05pF	0.50	±0.05	±0.05	0.24%	
	C1005NP0828□GTS	C1005NP0828□GT	1V, 1MHz	0.82	pF	±0.25pF,±0.1pF,±0.05pF	0.50	±0.05	±0.05	0.24%	
	C1005NP0908□GTS	C1005NP0908□GT	1V, 1MHz	0.90	pF	±0.25pF,±0.1pF,±0.05pF	0.50	±0.05	±0.05	0.24%	
	C1005NP0109□GTS	C1005NP0109□GT	1V, 1MHz	1.0	pF	±0.25pF,±0.1pF,±0.05pF	0.50	±0.05	±0.05	0.24%	
	C1005NP0129□GTS	C1005NP0129□GT	1V, 1MHz	1.2	pF	±0.25pF,±0.1pF,±0.05pF	0.50	±0.05	±0.05	0.24%	
	C1005NP0139□GTS	C1005NP0139□GT	1V, 1MHz	1.3	pF	±0.25pF,±0.1pF,±0.05pF	0.50	±0.05	±0.05	0.23%	
	C1005NP0159□GTS	C1005NP0159□GT	1V, 1MHz	1.5	pF	±0.25pF,±0.1pF,±0.05pF	0.50	±0.05	±0.05	0.23%	
	C1005NP0169□GTS	C1005NP0169□GT	1V, 1MHz	1.6	pF	±0.25pF,±0.1pF	0.50	±0.05	±0.05	0.23%	
	C1005NP0179□GTS	C1005NP0179□GT	1V, 1MHz	1.7	pF	±0.25pF,±0.1pF	0.50	±0.05	±0.05	0.23%	
	C1005NP0189□GTS	C1005NP0189□GT	1V, 1MHz	1.8	pF	±0.25pF,±0.1pF,±0.05pF	0.50	±0.05	±0.05	0.23%	
	C1005NP0199□GTS	C1005NP0199□GT	1V, 1MHz	1.9	pF	±0.25pF,±0.1pF,±0.05pF	0.50	±0.05	±0.05	0.23%	
	C1005NP0209□GTS	C1005NP0209□GT	1V, 1MHz	2.0	pF	±0.25pF,±0.1pF,±0.05pF	0.50	±0.05	±0.05	0.23%	
	C1005NP0229□GTS	C1005NP0229□GT	1V, 1MHz	2.2	pF	±0.25pF,±0.1pF,±0.05pF	0.50	±0.05	±0.05	0.23%	
	C1005NP0249□GTS	C1005NP0249□GT	1V, 1MHz	2.4	pF	±0.25pF,±0.1pF,±0.05pF	0.50	±0.05	±0.05	0.22%	
	C1005NP0259□GTS	C1005NP0259□GT	1V, 1MHz	2.5	pF	±0.25pF,±0.1pF,±0.05pF	0.50	±0.05	±0.05	0.22%	
	C1005NP0279□GTS	C1005NP0279□GT	1V, 1MHz	2.7	pF	±0.25pF,±0.1pF,±0.05pF	0.50	±0.05	±0.05	0.22%	
	C1005NP0309□GTS	C1005NP0309□GT	1V, 1MHz	3.0	pF	±0.25pF,±0.1pF,±0.05pF	0.50	±0.05	±0.05	0.22%	
	C1005NP0339□GTS	C1005NP0339□GT	1V, 1MHz	3.3	pF	±0.5pF,±0.25pF,±0.1pF,±0.05pF	0.50	±0.05	±0.05	0.21%	
	C1005NP0359□GTS	C1005NP0359□GT	1V, 1MHz	3.5	pF	±0.25pF,±0.1pF,±0.05pF	0.50	±0.05	±0.05	0.21%	
	C1005NP0369□GTS	C1005NP0369□GT	1V, 1MHz	3.6	pF	±0.25pF,±0.1pF,±0.05pF	0.50	±0.05	±0.05	0.21%	
	C1005NP0399□GTS	C1005NP0399□GT	1V, 1MHz	3.9	pF	±0.25pF,±0.1pF,±0.05pF	0.50	±0.05	±0.05	0.21%	
	C1005NP0409□GTS	C1005NP0409□GT	1V, 1MHz	4.0	pF	±0.25pF,±0.1pF,±0.05pF	0.50	±0.05	±0.05	0.21%	
	C1005NP0439□GTS	C1005NP0439□GT	1V, 1MHz	4.3	pF	±0.25pF,±0.1pF,±0.05pF	0.50	±0.05	±0.05	0.21%	
	C1005NP0459□GTS	C1005NP0459□GT	1V, 1MHz	4.5	pF	±0.25pF,±0.1pF,±0.05pF	0.50	±0.05	±0.05	0.20%	
	C1005NP0479□GTS	C1005NP0479□GT	1V, 1MHz	4.7	pF	±0.25pF,±0.1pF,±0.05pF	0.50	±0.05	±0.05	0.20%	
	C1005NP0509□GTS	C1005NP0509□GT	1V, 1MHz	5.0	pF	±0.5pF,±0.25pF,±0.1pF,±0.05pF	0.50	±0.05	±0.05	0.20%	
	C1005NP0519□GTS	C1005NP0519□GT	1V, 1MHz	5.1	pF	±0.5pF,±0.25pF,±0.1pF	0.50	±0.05	±0.05	0.20%	
	C1005NP0569□GTS	C1005NP0569□GT	1V, 1MHz	5.6	pF	±0.5pF,±0.25pF,±0.1pF	0.50	±0.05	±0.05	0.20%	
	C1005NP0609□GTS	C1005NP0609□GT	1V, 1MHz	6.0	pF	±0.5pF,±0.25pF,±0.1pF	0.50	±0.05	±0.05	0.19%	
	C1005NP0629□GTS	C1005NP0629□GT	1V, 1MHz	6.2	pF	±0.5pF,±0.25pF,±0.1pF	0.50	±0.05	±0.05	0.19%	
	C1005NP0689□GTS	C1005NP0689□GT	1V, 1MHz	6.8	pF	±0.5pF,±0.25pF,±0.1pF	0.50	±0.05	±0.05	0.19%	
	C1005NP0709□GTS	C1005NP0709□GT	1V, 1MHz	7.0	pF	±0.5pF,±0.25pF,±0.1pF	0.50	±0.05	±0.05	0.19%	
	C1005NP0759□GTS	C1005NP0759□GT	1V, 1MHz	7.5	pF	±0.5pF,±0.25pF,±0.1pF	0.50	±0.05	±0.05	0.18%	
	C1005NP0809□GTS	C1005NP0809□GT	1V, 1MHz	8.0	pF	±0.5pF,±0.25pF,±0.1pF	0.50	±0.05	±0.05	0.18%	
	C1005NP0829□GTS	C1005NP0829□GT	1V, 1MHz	8.2	pF	±0.5pF,±0.25pF,±0.1pF	0.50	±0.05	±0.05	0.18%	
C1005NP0909□GTS	C1005NP0909□GT	1V, 1MHz	9.0	pF	±0.5pF,±0.25pF,±0.1pF	0.50	±0.05	±0.05	0.17%		
C1005NP0919□GTS	C1005NP0919□GT	1V, 1MHz	9.1	pF	±0.5pF,±0.25pF,±0.1pF	0.50	±0.05	±0.05	0.17%		
C1005NP0100□GTS	C1005NP0100□GT	1V, 1MHz	10	pF	±5%,±2%,±1%	0.50	±0.05	±0.05	0.17%		
C1005NP0110□GTS	C1005NP0110□GT	1V, 1MHz	11	pF	±5%,±2%,±1%	0.50	±0.05	±0.05	0.16%		
C1005NP0120□GTS	C1005NP0120□GT	1V, 1MHz	12	pF	±5%,±2%,±1%	0.50	±0.05	±0.05	0.16%		
C1005NP0130□GTS	C1005NP0130□GT	1V, 1MHz	13	pF	±5%,±2%	0.50	±0.05	±0.05	0.15%		
C1005NP0150□GTS	C1005NP0150□GT	1V, 1MHz	15	pF	±5%,±2%,±1%	0.50	±0.05	±0.05	0.14%		
C1005NP0160□GTS	C1005NP0160□GT	1V, 1MHz	16	pF	±5%,±2%,±1%	0.50	±0.05	±0.05	0.14%		
C1005NP0180□GTS	C1005NP0180□GT	1V, 1MHz	18	pF	±10%,±5%,±2%,±1%	0.50	±0.05	±0.05	0.13%		
C1005NP0200□GTS	C1005NP0200□GT	1V, 1MHz	20	pF	±5%,±2%,±1%	0.50	±0.05	±0.05	0.13%		
C1005NP0220□GTS	C1005NP0220□GT	1V, 1MHz	22	pF	±10%,±5%,±2%,±1%	0.50	±0.05	±0.05	0.12%		
C1005NP0240□GTS	C1005NP0240□GT	1V, 1MHz	24	pF	±5%,±2%,±1%	0.50	±0.05	±0.05	0.11%		
C1005NP0270□GTS	C1005NP0270□GT	1V, 1MHz	27	pF	±5%,±2%,±1%	0.50	±0.05	±0.05	0.11%		
C1005NP0300□GTS	C1005NP0300□GT	1V, 1MHz	30	pF	±5%,±2%,±1%	0.50	±0.05	±0.05	0.10%		
C1005NP0330□GTS	C1005NP0330□GT	1V, 1MHz	33	pF	±10%,±5%,±2%,±1%	0.50	±0.05	±0.05	0.10%		
C1005NP0360□GTS	C1005NP0360□GT	1V, 1MHz	36	pF	±5%,±2%,±1%	0.50	±0.05	±0.05	0.10%		
C1005NP0390□GTS	C1005NP0390□GT	1V, 1MHz	39	pF	±5%,±2%,±1%	0.50	±0.05	±0.05	0.10%		
C1005NP0430□GTS	C1005NP0430□GT	1V, 1MHz	43	pF	±5%,±2%,±1%	0.50	±0.05	±0.05	0.10%		
C1005NP0470□GTS	C1005NP0470□GT	1V, 1MHz	47	pF	±10%,±5%,±2%,±1%	0.50	±0.05	±0.05	0.10%		
C1005NP0510□GTS	C1005NP0510□GT	1V, 1MHz	51	pF	±5%,±2%,±1%	0.50	±0.05	±0.05	0.10%		
C1005NP0560□GTS	C1005NP0560□GT	1V, 1MHz	56	pF	±5%,±2%,±1%	0.50	±0.05	±0.05	0.10%		
C1005NP0620□GTS	C1005NP0620□GT	1V, 1MHz	62	pF	±5%,±2%,±1%	0.50	±0.05	±0.05	0.10%		
C1005NP0680□GTS	C1005NP0680□GT	1V, 1MHz	68	pF	±5%,±2%,±1%	0.50	±0.05	±0.05	0.10%		
C1005NP0750□GTS	C1005NP0750□GT	1V, 1MHz	75	pF	±5%,±2%,±1%	0.50	±0.05	±0.05	0.10%		
C1005NP0820□GTS	C1005NP0820□GT	1V, 1MHz	82	pF	±5%,±2%,±1%	0.50	±0.05	±0.05	0.10%		
C1005NP0910□GTS	C1005NP0910□GT	1V, 1MHz	91	pF	±5%,±2%,±1%	0.50	±0.05	±0.05	0.10%		
C1005NP0101□GTS	C1005NP0101□GT	1V, 1MHz	100	pF	±10%,±5%,±2%,±1%	0.50	±0.05	±0.05	0.10%		
C1005NP0121□GTS	C1005NP0121□GT	1V, 1MHz	120	pF	±10%,±5%,±2%,±1%	0.50	±0.05	±0.05	0.10%		
C1005NP0131JGTS	C1005NP0131JGT	1V, 1MHz	130	pF	±5%	0.50	±0.05	±0.05	0.10%		
C1005NP0151□GTS	C1005NP0151□GT	1V, 1MHz	150	pF	±5%,±2%,±1%	0.50	±0.05	±0.05	0.10%		
C1005NP0181□GTS	C1005NP0181□GT	1V, 1MHz	180	pF	±5%,±2%,±1%	0.50	±0.05	±0.05	0.10%		
C1005NP0201□GTS	C1005NP0201□GT	1V, 1MHz	200	pF	±5%,±2%,±1%	0.50	±0.05	±0.05	0.10%		
C1005NP0221□GTS	C1005NP0221□GT	1V, 1MHz	220	pF	±5%,±2%,±1%	0.50	±0.05	±0.05	0.10%		

□ Tolerance Code: A=±0.05 pF, B=±0.1pF, C=±0.25pF, D=±0.5pF, F=±1%, G=±2%, J=±5%; Special tolerance on the request.

RV	DARFON P/N	DARFON P/N 2	Measuring Condition	Capacitance		Available Tolerance	Thick. (mm)	Tolerance(mm)		DF (max.)	Standard Packing
				Value	Unit			L/W	Thick.		
50V	C1005NP0271□GTS	C1005NP0271□GT	1V, 1MHz	270	pF	±5%,±2%,±1%	0.50	±0.05	±0.05	0.10%	Paper, 10Kpcs
	C1005NP0301□GTS	C1005NP0301□GT	1V, 1MHz	300	pF	±5%,±2%	0.50	±0.05	±0.05	0.10%	
	C1005NP0331□GTS	C1005NP0331□GT	1V, 1MHz	330	pF	±5%,±2%	0.50	±0.05	±0.05	0.10%	
	C1005NP0391□GTS	C1005NP0391□GT	1V, 1MHz	390	pF	±5%,±2%,±1%	0.50	±0.05	±0.05	0.10%	
	C1005NP0471□GTS	C1005NP0471□GT	1V, 1MHz	470	pF	±5%,±2%,±1%	0.50	±0.05	±0.05	0.10%	
	C1005NP0561□GTS	C1005NP0561□GT	1V, 1MHz	560	pF	±5%,±2%,±1%	0.50	±0.05	±0.05	0.10%	
	C1005NP0681□GTS	C1005NP0681□GT	1V, 1MHz	680	pF	±5%,±2%,±1%	0.50	±0.05	±0.05	0.10%	
	C1005NP0751□GTS	C1005NP0751□GT	1V, 1MHz	750	pF	±5%,±2%	0.50	±0.05	±0.05	0.10%	
	C1005NP0821□GTS	C1005NP0821□GT	1V, 1MHz	820	pF	±5%,±2%	0.50	±0.05	±0.05	0.10%	
25V	C1005NP0102□GTS	C1005NP0102□GT	1V, 1MHz	1.0	nF	±5%,±2%,±1%	0.50	±0.05	±0.05	0.10%	Paper, 10Kpcs
	C1005NP0152JGTS	C1005NP0152JGT	1V, 1kHz	1.5	nF	±5%	0.50	±0.05	±0.05	0.10%	
	C1005NP0208□FTS	C1005NP0208□FT	1V, 1MHz	0.2	pF	±0.25pF,±0.1pF,±0.05pF	0.50	±0.05	±0.05	0.25%	
	C1005NP0308□FTS	C1005NP0308□FT	1V, 1MHz	0.3	pF	±0.25pF,±0.1pF,±0.05pF	0.50	±0.05	±0.05	0.25%	
	C1005NP0508□FTS	C1005NP0508□FT	1V, 1MHz	0.5	pF	±0.25pF,±0.1pF,±0.05pF	0.50	±0.05	±0.05	0.24%	
	C1005NP0169BFTS	C1005NP0169BFT	1V, 1MHz	1.6	pF	±0.1pF	0.50	±0.05	±0.05	0.23%	
	C1005NP0689□FTS	C1005NP0689□FT	1V, 1MHz	6.8	pF	±0.5pF,±0.25pF,±0.1pF	0.50	±0.05	±0.05	0.19%	
	C1005NP0100JFTS	C1005NP0100JFT	1V, 1MHz	10	pF	±5%	0.50	±0.05	±0.05	0.17%	
	C1005NP0120□FTS	C1005NP0120□FT	1V, 1MHz	12	pF	±5%,±2%,±1%	0.50	±0.05	±0.05	0.16%	
	C1005NP0160JFTS	C1005NP0160JFT	1V, 1MHz	16	pF	±5%	0.50	±0.05	±0.05	0.14%	
	C1005NP0180KFTS	C1005NP0180KFT	1V, 1MHz	18	pF	±10%	0.50	±0.05	±0.05	0.13%	
	C1005NP0220JFTS	C1005NP0220JFT	1V, 1MHz	22	pF	±5%	0.50	±0.05	±0.05	0.12%	
	C1005NP0240JFTS	C1005NP0240JFT	1V, 1MHz	24	pF	±5%	0.50	±0.05	±0.05	0.11%	
	C1005NP0270JFTS	C1005NP0270JFT	1V, 1MHz	27	pF	±5%	0.50	±0.05	±0.05	0.11%	
	C1005NP0330□FTS	C1005NP0330□FT	1V, 1MHz	33	pF	±10%,±5%	0.50	±0.05	±0.05	0.10%	
	C1005NP0470JFTS	C1005NP0470JFT	1V, 1MHz	47	pF	±5%	0.50	±0.05	±0.05	0.10%	
	C1005NP0560JFTS	C1005NP0560JFT	1V, 1MHz	56	pF	±5%	0.50	±0.05	±0.05	0.10%	
	C1005NP0101JFTS	C1005NP0101JFT	1V, 1MHz	100	pF	±5%	0.50	±0.05	±0.05	0.10%	
	C1005NP0201JFTS	C1005NP0201JFT	1V, 1MHz	200	pF	±5%	0.50	±0.05	±0.05	0.10%	
	C1005NP0221□FTS	C1005NP0221□FT	1V, 1MHz	220	pF	±10%,±5%	0.50	±0.05	±0.05	0.10%	
	C1005NP0271JFTS	C1005NP0271JFT	1V, 1MHz	270	pF	±5%	0.50	±0.05	±0.05	0.10%	
C1005NP0331JFTS	C1005NP0331JFT	1V, 1MHz	330	pF	±5%	0.50	±0.05	±0.05	0.10%		
C1005NP0471JFTS	C1005NP0471JFT	1V, 1MHz	470	pF	±5%	0.50	±0.05	±0.05	0.10%		
C1005NP0561JFTS	C1005NP0561JFT	1V, 1MHz	560	pF	±5%	0.50	±0.05	±0.05	0.10%		
C1005NP0102JFTS	C1005NP0102JFT	1V, 1MHz	1.0	nF	±5%	0.50	±0.05	±0.05	0.10%		
C1005NP0152JFTS	C1005NP0152JFT	1V, 1kHz	1.5	nF	±5%	0.50	±0.05	±0.05	0.10%		
C1005NP0182JFTS	C1005NP0182JFT	1V, 1kHz	1.8	nF	±5%	0.50	±0.05	±0.05	0.10%		
C1005NP0222JFTS	C1005NP0222JFT	1V, 1kHz	2.2	nF	±5%	0.50	±0.05	±0.05	0.10%		
16V	C1005NP0109BETS	C1005NP0109BET	1V, 1MHz	1.0	pF	±0.1pF	0.50	±0.05	±0.05	0.24%	Paper, 10Kpcs
	C1005NP0129BETS	C1005NP0129BET	1V, 1MHz	1.2	pF	±0.1pF	0.50	±0.05	±0.05	0.24%	
	C1005NP0209BETS	C1005NP0209BET	1V, 1MHz	2.0	pF	±0.1pF	0.50	±0.05	±0.05	0.23%	
	C1005NP0100JETS	C1005NP0100JET	1V, 1MHz	10	pF	±5%	0.50	±0.05	±0.05	0.17%	
	C1005NP0150□ETS	C1005NP0150□ET	1V, 1MHz	15	pF	±5%,±2%,±1%	0.50	±0.05	±0.05	0.14%	
	C1005NP0220FETS	C1005NP0220FET	1V, 1MHz	22	pF	±1%	0.50	±0.05	±0.05	0.12%	
	C1005NP0300JETS	C1005NP0300JET	1V, 1MHz	30	pF	±5%	0.50	±0.05	±0.05	0.10%	
	C1005NP0470□ETS	C1005NP0470□ET	1V, 1MHz	47	pF	±5%,±2%,±1%	0.50	±0.05	±0.05	0.10%	
	C1005NP0101JETS	C1005NP0101JET	1V, 1MHz	100	pF	±5%	0.50	±0.05	±0.05	0.10%	
	C1005NP0331□ETS	C1005NP0331□ET	1V, 1MHz	330	pF	±5%,±2%	0.50	±0.05	±0.05	0.10%	
	C1005NP0271JETS	C1005NP0271JET	1V, 1MHz	270	pF	±5%	0.50	±0.05	±0.05	0.10%	
C1005NP0471JETS	C1005NP0471JET	1V, 1MHz	470	pF	±5%	0.50	±0.05	±0.05	0.10%		
C1005NP0102JETS	C1005NP0102JET	1V, 1MHz	1.0	nF	±5%	0.50	±0.05	±0.05	0.10%		
10V	C1005NP0220□DTS	C1005NP0220□DT	1V, 1MHz	22	pF	±5%,±2%,±1%	0.50	±0.05	±0.05	0.12%	Paper, 10Kpcs

● C1608NP0 Series (EIA0603)

RV	DARFON P/N	DARFON P/N 2	Measuring Condition	Capacitance		Available Tolerance	Thick. (mm)	Tolerance(mm)		DF (max.)	Standard Packing
				Value	Unit			L/W	Thick.		
50V	C1608NP0308□GTS	C1608NP0308□GT	1V, 1MHz	0.30	pF	±0.25pF,±0.1pF,±0.05pF	0.80	±0.10	±0.10	0.25%	Paper, 4Kpcs
	C1608NP0478□GTS	C1608NP0478□GT	1V, 1MHz	0.47	pF	±0.25pF,±0.1pF,±0.05pF	0.80	±0.10	±0.10	0.24%	
	C1608NP0508□GTS	C1608NP0508□GT	1V, 1MHz	0.50	pF	±0.25pF,±0.1pF,±0.05pF	0.80	±0.10	±0.10	0.24%	
	C1608NP0568□GTS	C1608NP0568□GT	1V, 1MHz	0.56	pF	±0.25pF,±0.1pF,±0.05pF	0.80	±0.10	±0.10	0.24%	
	C1608NP0688□GTS	C1608NP0688□GT	1V, 1MHz	0.68	pF	±0.25pF,±0.1pF,±0.05pF	0.80	±0.10	±0.10	0.24%	
	C1608NP0758□GTS	C1608NP0758□GT	1V, 1MHz	0.75	pF	±0.25pF,±0.1pF,±0.05pF	0.80	±0.10	±0.10	0.24%	
	C1608NP0828□GTS	C1608NP0828□GT	1V, 1MHz	0.82	pF	±0.25pF,±0.1pF,±0.05pF	0.80	±0.10	±0.10	0.24%	
	C1608NP0109□GTS	C1608NP0109□GT	1V, 1MHz	1.0	pF	±0.25pF,±0.1pF	0.80	±0.10	±0.10	0.24%	
	C1608NP0129□GTS	C1608NP0129□GT	1V, 1MHz	1.2	pF	±0.25pF,±0.1pF	0.80	±0.10	±0.10	0.24%	
	C1608NP0159□GTS	C1608NP0159□GT	1V, 1MHz	1.5	pF	±0.25pF,±0.1pF	0.80	±0.10	±0.10	0.23%	
	C1608NP0189□GTS	C1608NP0189□GT	1V, 1MHz	1.8	pF	±0.25pF,±0.1pF	0.80	±0.10	±0.10	0.23%	
	C1608NP0209□GTS	C1608NP0209□GT	1V, 1MHz	2.0	pF	±0.25pF,±0.1pF	0.80	±0.10	±0.10	0.23%	
	C1608NP0229□GTS	C1608NP0229□GT	1V, 1MHz	2.2	pF	±0.25pF,±0.1pF	0.80	±0.10	±0.10	0.23%	
	C1608NP0249□GTS	C1608NP0249□GT	1V, 1MHz	2.4	pF	±0.25pF,±0.1pF	0.80	±0.10	±0.10	0.22%	
	C1608NP0279□GTS	C1608NP0279□GT	1V, 1MHz	2.7	pF	±0.25pF,±0.1pF	0.80	±0.10	±0.10	0.22%	
	C1608NP0309□GTS	C1608NP0309□GT	1V, 1MHz	3.0	pF	±0.25pF,±0.1pF	0.80	±0.10	±0.10	0.22%	
	C1608NP0339□GTS	C1608NP0339□GT	1V, 1MHz	3.3	pF	±0.25pF,±0.1pF	0.80	±0.10	±0.10	0.21%	
	C1608NP0399□GTS	C1608NP0399□GT	1V, 1MHz	3.9	pF	±0.25pF,±0.1pF	0.80	±0.10	±0.10	0.21%	
	C1608NP0409□GTS	C1608NP0409□GT	1V, 1MHz	4.0	pF	±0.25pF,±0.1pF	0.80	±0.10	±0.10	0.21%	
	C1608NP0479□GTS	C1608NP0479□GT	1V, 1MHz	4.7	pF	±0.25pF,±0.1pF	0.80	±0.10	±0.10	0.20%	
	C1608NP0509□GTS	C1608NP0509□GT	1V, 1MHz	5.0	pF	±0.5pF,±0.25pF,±0.1pF	0.80	±0.10	±0.10	0.20%	
	C1608NP0569□GTS	C1608NP0569□GT	1V, 1MHz	5.6	pF	±0.5pF,±0.25pF,±0.1pF	0.80	±0.10	±0.10	0.20%	
	C1608NP0609□GTS	C1608NP0609□GT	1V, 1MHz	6.0	pF	±0.5pF,±0.25pF,±0.1pF	0.80	±0.10	±0.10	0.19%	
	C1608NP0629□GTS	C1608NP0629□GT	1V, 1MHz	6.2	pF	±0.5pF,±0.25pF,±0.1pF	0.80	±0.10	±0.10	0.19%	
	C1608NP0689□GTS	C1608NP0689□GT	1V, 1MHz	6.8	pF	±0.5pF,±0.25pF,±0.1pF	0.80	±0.10	±0.10	0.19%	
	C1608NP0709□GTS	C1608NP0709□GT	1V, 1MHz	7.0	pF	±0.5pF,±0.25pF,±0.1pF	0.80	±0.10	±0.10	0.19%	
	C1608NP0809□GTS	C1608NP0809□GT	1V, 1MHz	8.0	pF	±0.5pF,±0.25pF,±0.1pF	0.80	±0.10	±0.10	0.18%	
	C1608NP0829□GTS	C1608NP0829□GT	1V, 1MHz	8.2	pF	±0.5pF,±0.25pF,±0.1pF	0.80	±0.10	±0.10	0.18%	
	C1608NP0909□GTS	C1608NP0909□GT	1V, 1MHz	9.0	pF	±0.5pF,±0.25pF,±0.1pF	0.80	±0.10	±0.10	0.17%	
	C1608NP0100□GTS	C1608NP0100□GT	1V, 1MHz	10	pF	±5%,±2%,±1%	0.80	±0.10	±0.10	0.17%	
	C1608NP0110□GTS	C1608NP0110□GT	1V, 1MHz	11	pF	±5%,±2%,±1%	0.80	±0.10	±0.10	0.16%	
	C1608NP0120□GTS	C1608NP0120□GT	1V, 1MHz	12	pF	±5%,±2%,±1%	0.80	±0.10	±0.10	0.16%	
	C1608NP0150□GTS	C1608NP0150□GT	1V, 1MHz	15	pF	±5%,±2%,±1%	0.80	±0.10	±0.10	0.14%	
	C1608NP0160□GTS	C1608NP0160□GT	1V, 1MHz	16	pF	±5%,±2%,±1%	0.80	±0.10	±0.10	0.14%	
	C1608NP0180□GTS	C1608NP0180□GT	1V, 1MHz	18	pF	±10%,±5%,±2%,±1%	0.80	±0.10	±0.10	0.13%	
	C1608NP0200□GTS	C1608NP0200□GT	1V, 1MHz	20	pF	±5%,±2%,±1%	0.80	±0.10	±0.10	0.13%	
	C1608NP0220□GTS	C1608NP0220□GT	1V, 1MHz	22	pF	±5%,±2%,±1%	0.80	±0.10	±0.10	0.12%	
	C1608NP0240□GTS	C1608NP0240□GT	1V, 1MHz	24	pF	±5%,±2%,±1%	0.80	±0.10	±0.10	0.11%	
	C1608NP0270□GTS	C1608NP0270□GT	1V, 1MHz	27	pF	±5%,±2%,±1%	0.80	±0.10	±0.10	0.11%	
	C1608NP0300□GTS	C1608NP0300□GT	1V, 1MHz	30	pF	±5%,±2%,±1%	0.80	±0.10	±0.10	0.10%	
	C1608NP0330□GTS	C1608NP0330□GT	1V, 1MHz	33	pF	±5%,±2%,±1%	0.80	±0.10	±0.10	0.10%	
	C1608NP0360□GTS	C1608NP0360□GT	1V, 1MHz	36	pF	±5%,±2%,±1%	0.80	±0.10	±0.10	0.10%	
C1608NP0390□GTS	C1608NP0390□GT	1V, 1MHz	39	pF	±5%,±2%,±1%	0.80	±0.10	±0.10	0.10%		
C1608NP0430□GTS	C1608NP0430□GT	1V, 1MHz	43	pF	±5%,±2%,±1%	0.80	±0.10	±0.10	0.10%		
C1608NP0470□GTS	C1608NP0470□GT	1V, 1MHz	47	pF	±5%,±2%,±1%	0.80	±0.10	±0.10	0.10%		
C1608NP0510□GTS	C1608NP0510□GT	1V, 1MHz	51	pF	±5%,±2%	0.80	±0.10	±0.10	0.10%		
C1608NP0560□GTS	C1608NP0560□GT	1V, 1MHz	56	pF	±10%,±5%,±2%,±1%	0.80	±0.10	±0.10	0.10%		
C1608NP0620□GTS	C1608NP0620□GT	1V, 1MHz	62	pF	±5%,±2%,±1%	0.80	±0.10	±0.10	0.10%		
C1608NP0680□GTS	C1608NP0680□GT	1V, 1MHz	68	pF	±5%,±2%,±1%	0.80	±0.10	±0.10	0.10%		
C1608NP0750□GTS	C1608NP0750□GT	1V, 1MHz	75	pF	±5%,±2%,±1%	0.80	±0.10	±0.10	0.10%		
C1608NP0820□GTS	C1608NP0820□GT	1V, 1MHz	82	pF	±5%,±2%,±1%	0.80	±0.10	±0.10	0.10%		
C1608NP0910□GTS	C1608NP0910□GT	1V, 1MHz	91	pF	±5%,±2%,±1%	0.80	±0.10	±0.10	0.10%		
C1608NP0101□GTS	C1608NP0101□GT	1V, 1MHz	100	pF	±5%,±2%,±1%	0.80	±0.10	±0.10	0.10%		
C1608NP0121□GTS	C1608NP0121□GT	1V, 1MHz	120	pF	±5%,±2%,±1%	0.80	±0.10	±0.10	0.10%		
C1608NP0151□GTS	C1608NP0151□GT	1V, 1MHz	150	pF	±5%,±2%,±1%	0.80	±0.10	±0.10	0.10%		
C1608NP0181□GTS	C1608NP0181□GT	1V, 1MHz	180	pF	±5%,±2%,±1%	0.80	±0.10	±0.10	0.10%		
C1608NP0201□GTS	C1608NP0201□GT	1V, 1MHz	200	pF	±5%,±2%,±1%	0.80	±0.10	±0.10	0.10%		
C1608NP0221□GTS	C1608NP0221□GT	1V, 1MHz	220	pF	±5%,±2%,±1%	0.80	±0.10	±0.10	0.10%		

RV	DARFON P/N	DARFON P/N 2	Measuring Condition	Capacitance		Available Tolerance	Thick. (mm)	Tolerance(mm)		DF (max.)	Standard Packing
				Value	Unit			L/W	Thick.		
50V	C1608NP0271□GTS	C1608NP0271□GT	1V, 1MHz	270	pF	±5%, ±2%	0.80	±0.10	±0.10	0.10%	Paper, 4Kpcs
	C1608NP0301JGTS	C1608NP0301JGT	1V, 1MHz	300	pF	±5%	0.80	±0.10	±0.10	0.10%	
	C1608NP0331□GTS	C1608NP0331□GT	1V, 1MHz	330	pF	±5%, ±2%	0.80	±0.10	±0.10	0.10%	
	C1608NP0391□GTS	C1608NP0391□GT	1V, 1MHz	390	pF	±5%, ±2%	0.80	±0.10	±0.10	0.10%	
	C1608NP0431JGTS	C1608NP0431JGT	1V, 1MHz	430	pF	±5%	0.80	±0.10	±0.10	0.10%	
	C1608NP0471□GTS	C1608NP0471□GT	1V, 1MHz	470	pF	±5%, ±2%, ±1%	0.80	±0.10	±0.10	0.10%	
	C1608NP0561□GTS	C1608NP0561□GT	1V, 1MHz	560	pF	±5%, ±2%	0.80	±0.10	±0.10	0.10%	
	C1608NP0681□GTS	C1608NP0681□GT	1V, 1MHz	680	pF	±5%, ±2%	0.80	±0.10	±0.10	0.10%	
	C1608NP0751JGTS	C1608NP0751JGT	1V, 1MHz	750	pF	±5%	0.80	±0.10	±0.10	0.10%	
	C1608NP0821□GTS	C1608NP0821□GT	1V, 1MHz	820	pF	±5%, ±2%	0.80	±0.10	±0.10	0.10%	
	C1608NP0102□GTS	C1608NP0102□GT	1V, 1MHz	1.0	nF	±5%, ±2%, ±1%	0.80	±0.10	±0.10	0.10%	
	C1608NP0122JGTS	C1608NP0122JGT	1V, 1kHz	1.2	nF	±5%	0.80	+0.15/-0.10	+0.15/-0.10	0.10%	
	C1608NP0152□GTS	C1608NP0152□GT	1V, 1kHz	1.5	nF	±5%, ±2%	0.80	+0.15/-0.10	+0.15/-0.10	0.10%	
	C1608NP0182JGTS	C1608NP0182JGT	1V, 1kHz	1.8	nF	±5%	0.80	+0.15/-0.10	+0.15/-0.10	0.10%	
	C1608NP0222JGTS	C1608NP0222JGT	1V, 1kHz	2.2	nF	±5%	0.80	+0.15/-0.10	+0.15/-0.10	0.10%	
	C1608NP0272JGTS	C1608NP0272JGT	1V, 1kHz	2.7	nF	±5%	0.80	+0.15/-0.10	+0.15/-0.10	0.10%	
	C1608NP0332JGTS	C1608NP0332JGT	1V, 1kHz	3.3	nF	±5%	0.80	+0.15/-0.10	+0.15/-0.10	0.10%	
	C1608NP0392JGTS	C1608NP0392JGT	1V, 1kHz	3.9	nF	±5%	0.80	+0.15/-0.10	+0.15/-0.10	0.10%	
C1608NP0472□GTS	C1608NP0472□GT	1V, 1kHz	4.7	nF	±5%, ±2%, ±1%	0.80	+0.15/-0.10	+0.15/-0.10	0.10%		
C1608NP0562JGTS	C1608NP0562JGT	1V, 1kHz	5.6	nF	±5%	0.80	+0.15/-0.10	+0.15/-0.10	0.10%		
C1608NP0682JGTS	C1608NP0682JGT	1V, 1kHz	6.8	nF	±5%	0.80	+0.15/-0.10	+0.15/-0.10	0.10%		
C1608NP0822JGTS	C1608NP0822JGT	1V, 1kHz	8.2	nF	±5%	0.80	+0.15/-0.10	+0.15/-0.10	0.10%		
C1608NP0103JGTS	C1608NP0103JGT	1V, 1kHz	10	nF	±5%	0.80	+0.15/-0.10	+0.15/-0.10	0.10%		
25V	C1608NP0279CFTS	C1608NP0279CFT	1V, 1MHz	2.7	pF	±0.25pF	0.80	±0.10	±0.10	0.22%	Paper, 4Kpcs
	C1608NP0309CFTS	C1608NP0309CFT	1V, 1MHz	3.0	pF	±0.25pF	0.80	±0.10	±0.10	0.22%	
	C1608NP0609DFTS	C1608NP0609DFT	1V, 1MHz	6.0	pF	±0.5pF	0.80	±0.10	±0.10	0.19%	
	C1608NP0220JFTS	C1608NP0220JFT	1V, 1MHz	22	pF	±5%	0.80	±0.10	±0.10	0.12%	
	C1608NP0330JFTS	C1608NP0330JFT	1V, 1MHz	33	pF	±5%	0.80	±0.10	±0.10	0.10%	
	C1608NP0470JFTS	C1608NP0470JFT	1V, 1MHz	47	pF	±5%	0.80	±0.10	±0.10	0.10%	
	C1608NP0101□FTS	C1608NP0101□FT	1V, 1MHz	100	pF	±10%, ±5%	0.80	±0.10	±0.10	0.10%	
	C1608NP0121□FTS	C1608NP0121□FT	1V, 1MHz	120	pF	±10%, ±5%	0.80	±0.10	±0.10	0.10%	
	C1608NP0471□FTS	C1608NP0471□FT	1V, 1MHz	470	pF	±10%, ±5%	0.80	±0.10	±0.10	0.10%	
	C1608NP0102JFTS	C1608NP0102JFT	1V, 1MHz	1.0	nF	±5%	0.80	±0.10	±0.10	0.10%	
	C1608NP0152JFTS	C1608NP0152JFT	1V, 1kHz	1.5	nF	±5%	0.80	+0.15/-0.10	+0.15/-0.10	0.10%	
	C1608NP0222JFTS	C1608NP0222JFT	1V, 1kHz	2.2	nF	±5%	0.80	+0.15/-0.10	+0.15/-0.10	0.10%	
C1608NP0682JFTS	C1608NP0682JFT	1V, 1kHz	6.8	nF	±5%	0.80	+0.15/-0.10	+0.15/-0.10	0.10%		
C1608NP0822JFTS	C1608NP0822JFT	1V, 1kHz	8.2	nF	±5%	0.80	+0.15/-0.10	+0.15/-0.10	0.10%		
C1608NP0103JFTS	C1608NP0103JFT	1V, 1kHz	10	nF	±5%	0.80	+0.15/-0.10	+0.15/-0.10	0.10%		
16V	C1608NP0180□ETS	C1608NP0180□ET	1V, 1MHz	18	pF	±5%, ±2%, ±1%	0.80	±0.10	±0.10	0.13%	Paper, 4Kpcs
	C1608NP0300JETS	C1608NP0300JET	1V, 1MHz	30	pF	±5%	0.80	±0.10	±0.10	0.10%	
	C1608NP0152JETS	C1608NP0152JET	1V, 1kHz	1.5	nF	±5%	0.80	+0.15/-0.10	+0.15/-0.10	0.10%	
	C1608NP0222JETS	C1608NP0222JET	1V, 1kHz	2.2	nF	±5%	0.80	+0.15/-0.10	+0.15/-0.10	0.10%	
	C1608NP0272JETS	C1608NP0272JET	1V, 1kHz	2.7	nF	±5%	0.80	+0.15/-0.10	+0.15/-0.10	0.10%	
	C1608NP0332JETS	C1608NP0332JET	1V, 1kHz	3.3	nF	±5%	0.80	+0.15/-0.10	+0.15/-0.10	0.10%	
10V	C1608NP0101□DTS	C1608NP0101□DT	1V, 1MHz	100	pF	±10%, ±5%	0.80	±0.10	±0.10	0.10%	Paper, 4Kpcs

□ Tolerance Code: F=±1%, G=±2%, J=±5%; Special tolerance on the request.

● C2012NP0 Series (EIA0805)

RV	DARFON P/N	DARFON P/N 2	Measuring Condition	Capacitance		Available Tolerance	Thick. (mm)	Tolerance(mm)		DF (max.)	Standard Packing
				Value	Unit			L/W	Thick.		
50V	C2012NP0100□GTS	C2012NP0100□GT	1V, 1MHz	10	pF	±10%,±5%,±2%	0.60	±0.15	±0.15	0.17%	Paper, 4Kpcs
	C2012NP0120□GTS	C2012NP0120□GT	1V, 1MHz	12	pF	±5%,±2%	0.60	±0.15	±0.15	0.16%	
	C2012NP0150□GTS	C2012NP0150□GT	1V, 1MHz	15	pF	±5%,±2%	0.60	±0.15	±0.15	0.14%	
	C2012NP0180□GTS	C2012NP0180□GT	1V, 1MHz	18	pF	±5%,±2%	0.60	±0.15	±0.15	0.13%	
	C2012NP0200□GTS	C2012NP0200□GT	1V, 1MHz	20	pF	±5%,±2%	0.60	±0.15	±0.15	0.13%	
	C2012NP0220□GTS	C2012NP0220□GT	1V, 1MHz	22	pF	±5%,±2%	0.60	±0.15	±0.15	0.12%	
	C2012NP0270□GTS	C2012NP0270□GT	1V, 1MHz	27	pF	±5%,±2%	0.60	±0.15	±0.15	0.11%	
	C2012NP0300□GTS	C2012NP0300□GT	1V, 1MHz	30	pF	±5%,±2%	0.60	±0.15	±0.15	0.10%	
	C2012NP0330□GTS	C2012NP0330□GT	1V, 1MHz	33	pF	±10%,±5%,±2%	0.60	±0.15	±0.15	0.10%	
	C2012NP0360□GTS	C2012NP0360□GT	1V, 1MHz	36	pF	±5%,±2%	0.60	±0.15	±0.15	0.10%	
	C2012NP0390□GTS	C2012NP0390□GT	1V, 1MHz	39	pF	±5%,±2%	0.60	±0.15	±0.15	0.10%	
	C2012NP0470□GTS	C2012NP0470□GT	1V, 1MHz	47	pF	±10%,±5%,±2%	0.60	±0.15	±0.15	0.10%	
	C2012NP0560□GTS	C2012NP0560□GT	1V, 1MHz	56	pF	±10%,±5%	0.60	±0.15	±0.15	0.10%	
	C2012NP0680□GTS	C2012NP0680□GT	1V, 1MHz	68	pF	±5%,±2%	0.60	±0.15	±0.15	0.10%	
	C2012NP0820□GTS	C2012NP0820□GT	1V, 1MHz	82	pF	±5%,±2%	0.60	±0.15	±0.15	0.10%	
	C2012NP0101□GTS	C2012NP0101□GT	1V, 1MHz	100	pF	±5%,±2%,±1%	0.60	±0.15	±0.15	0.10%	
	C2012NP0121JGTS	C2012NP0121JGT	1V, 1MHz	120	pF	±5%	0.60	±0.15	±0.15	0.10%	
	C2012NP0151JGTS	C2012NP0151JGT	1V, 1MHz	150	pF	±5%	0.60	±0.15	±0.15	0.10%	
	C2012NP0181JGTS	C2012NP0181JGT	1V, 1MHz	180	pF	±5%	0.60	±0.15	±0.15	0.10%	
	C2012NP0201JGTS	C2012NP0201JGT	1V, 1MHz	200	pF	±5%	0.60	±0.15	±0.15	0.10%	
	C2012NP0221□GTS	C2012NP0221□GT	1V, 1MHz	220	pF	±5%,±2%,±1%	0.60	±0.15	±0.15	0.10%	
	C2012NP0271JGTS	C2012NP0271JGT	1V, 1MHz	270	pF	±5%	0.60	±0.15	±0.15	0.10%	
	C2012NP0331JGTS	C2012NP0331JGT	1V, 1MHz	330	pF	±5%	0.60	±0.15	±0.15	0.10%	
	C2012NP0391JGTS	C2012NP0391JGT	1V, 1MHz	390	pF	±5%	0.60	±0.15	±0.15	0.10%	
	C2012NP0471JGTS	C2012NP0471JGT	1V, 1MHz	470	pF	±5%	0.60	±0.15	±0.15	0.10%	
	C2012NP0471JGTSE		1V, 1MHz	470	pF	±5%	0.85	±0.15	±0.15	0.10%	
	C2012NP0561JGTS	C2012NP0561JGT	1V, 1MHz	560	pF	±5%	0.60	±0.15	±0.15	0.10%	
	C2012NP0681JGTS	C2012NP0681JGT	1V, 1MHz	680	pF	±5%	0.60	±0.15	±0.15	0.10%	
	C2012NP0821JGTS	C2012NP0821JGT	1V, 1MHz	820	pF	±5%	0.60	±0.15	±0.15	0.10%	
	C2012NP0102JGTS	C2012NP0102JGT	1V, 1MHz	1.0	nF	±5%	0.60	±0.15	±0.15	0.10%	
	C2012NP0122JGTS	C2012NP0122JGT	1V, 1kHz	1.2	nF	±5%	0.85	±0.15	±0.15	0.10%	
	C2012NP0152JGTS	C2012NP0152JGT	1V, 1kHz	1.5	nF	±5%	0.85	±0.15	±0.15	0.10%	
	C2012NP0182JGTS	C2012NP0182JGT	1V, 1kHz	1.8	nF	±5%	0.85	±0.15	±0.15	0.10%	
C2012NP0222JGTS	C2012NP0222JGT	1V, 1kHz	2.2	nF	±5%	0.85	±0.15	±0.15	0.10%		
C2012NP0272JGTS	C2012NP0272JGT	1V, 1kHz	2.7	nF	±5%	0.85	±0.15	±0.15	0.10%		
C2012NP0272JGPS	C2012NP0272JGP	1V, 1kHz	2.7	nF	±5%	1.25	±0.15	±0.20	0.10%		
C2012NP0332JGTS	C2012NP0332JGT	1V, 1kHz	3.3	nF	±5%	0.85	±0.15	±0.15	0.10%		
C2012NP0332JGPS	C2012NP0332JGP	1V, 1kHz	3.3	nF	±5%	1.25	±0.15	±0.20	0.10%		
C2012NP0392JGTS	C2012NP0392JGT	1V, 1kHz	3.9	nF	±5%	0.85	±0.15	±0.15	0.10%		
C2012NP0392JGPS	C2012NP0392JGP	1V, 1kHz	3.9	nF	±5%	1.25	±0.15	±0.20	0.10%		
C2012NP0472JGTS	C2012NP0472JGT	1V, 1kHz	4.7	nF	±5%	0.85	±0.15	±0.15	0.10%		
C2012NP0472JGPS	C2012NP0472JGP	1V, 1kHz	4.7	nF	±5%	1.25	±0.15	±0.20	0.10%		
C2012NP0562JGTS	C2012NP0562JGP	1V, 1kHz	5.6	nF	±5%	1.25	±0.15	±0.20	0.10%		
C2012NP0682JGTS	C2012NP0682JGP	1V, 1kHz	6.8	nF	±5%	1.25	±0.15	±0.20	0.10%		
C2012NP0822JGTS	C2012NP0822JGP	1V, 1kHz	8.2	nF	±5%	1.25	±0.15	±0.20	0.10%		
C2012NP0103JGTS	C2012NP0103JGT	1V, 1kHz	10	nF	±5%	0.85	±0.15	±0.10	0.10%		
C2012NP0103□GPS	C2012NP0103□GP	1V, 1kHz	10	nF	±5%,±2%,±1%	1.25	±0.15	±0.20	0.10%		
C2012NP0223JGPS	C2012NP0223JGP	1V, 1kHz	22	nF	±5%	1.25	±0.15	±0.20	0.10%		
25V	C2012NP0222JFETS	C2012NP0222JFT	1V, 1kHz	2.2	nF	±5%	0.85	±0.15	±0.15	0.10%	Paper, 4Kpcs
16V	C2012NP0100JETS	C2012NP0100JET	1V, 1MHz	10	pF	±5%	0.60	±0.15	±0.15	0.17%	Paper, 4Kpcs
	C2012NP0270□ETS	C2012NP0270□ET	1V, 1MHz	27	pF	±5%,±2%	0.60	±0.15	±0.15	0.11%	
	C2012NP0332JEPS	C2012NP0332JEP	1V, 1kHz	3.3	nF	±5%	1.25	±0.15	±0.20	0.10%	

● C3216NP0 Series (EIA1206)

RV	DARFON P/N	DARFON P/N 2	Measuring Condition	Capacitance		Available Tolerance	Thick. (mm)	Tolerance(mm)		DF (max.)	Standard Packing
				Value	Unit			L/W	Thick.		
50V	C3216NP0100JGTS	C3216NP0100JGT	1V, 1MHz	10	pF	±5%	0.80	±0.15	±0.10	0.17%	Paper,4Kpcs
	C3216NP0220JGTS	C3216NP0220JGT	1V, 1MHz	22	pF	±5%	0.80	±0.15	±0.10	0.12%	
	C3216NP0101JGTS	C3216NP0101JGT	1V, 1MHz	100	pF	±5%	0.80	±0.15	±0.10	0.10%	
	C3216NP0221JGTS	C3216NP0221JGT	1V, 1MHz	220	pF	±5%	0.80	±0.15	±0.10	0.10%	
	C3216NP0152JGTS	C3216NP0152JGT	1V, 1kHz	1.5	nF	±5%	0.80	±0.15	±0.10	0.10%	Embossed, 3Kpcs
	C3216NP0222JGTS	C3216NP0222JGT	1V, 1kHz	2.2	nF	±5%	0.80	±0.15	±0.10	0.10%	
	C3216NP0822JGPS	C3216NP0822JGP	1V, 1kHz	8.2	nF	±5%	1.25	±0.15	±0.20	0.10%	Embossed, 2Kpcs
	C3216NP0103JGPS	C3216NP0103JGP	1V, 1kHz	10	nF	±5%	1.25	±0.15	±0.20	0.10%	
	C3216NP0123JGPS	C3216NP0123JGP	1V, 1kHz	12	nF	±5%	1.60	±0.30	±0.30	0.10%	
	C3216NP0153JGPS	C3216NP0153JGP	1V, 1kHz	15	nF	±5%	1.60	±0.30	±0.30	0.10%	
	C3216NP0183JGPS	C3216NP0183JGP	1V, 1kHz	18	nF	±5%	1.60	±0.30	±0.30	0.10%	
	C3216NP0223JGPS	C3216NP0223JGP	1V, 1kHz	22	nF	±5%	1.60	±0.30	±0.30	0.10%	
	C3216NP0273JGPS	C3216NP0273JGP	1V, 1kHz	27	nF	±5%	1.60	±0.30	±0.30	0.10%	
	C3216NP0333JGPS	C3216NP0333JGP	1V, 1kHz	33	nF	±5%	1.60	±0.30	±0.30	0.10%	
C3216NP0393JGPS	C3216NP0393JGP	1V, 1kHz	39	nF	±5%	1.60	±0.30	±0.30	0.10%		
C3216NP0104JGPS	C3216NP0104JGP	1V, 1kHz	100	nF	±5%	1.60	±0.30	±0.30	0.10%	Embossed, 2Kpcs	
25V	C3216NP0104JFPS	C3216NP0104JFP	1V, 1kHz	100	nF	±5%	1.60	±0.30	±0.30	0.10%	Embossed, 2Kpcs
16V	C3216NP0123JEPS	C3216NP0123JEP	1V, 1kHz	12	nF	±5%	1.60	±0.30	±0.30	0.10%	Embossed, 2Kpcs
	C3216NP0153JEPS	C3216NP0153JEP	1V, 1kHz	15	nF	±5%	1.60	±0.30	±0.30	0.10%	
	C3216NP0183JEPS	C3216NP0183JEP	1V, 1kHz	18	nF	±5%	1.60	±0.30	±0.30	0.10%	
	C3216NP0223JEPS	C3216NP0223JEP	1V, 1kHz	22	nF	±5%	1.60	±0.30	±0.30	0.10%	
	C3216NP0273JEPS	C3216NP0273JEP	1V, 1kHz	27	nF	±5%	1.60	±0.30	±0.30	0.10%	
	C3216NP0333JEPS	C3216NP0333JEP	1V, 1kHz	33	nF	±5%	1.60	±0.30	±0.30	0.10%	
C3216NP0393JEPS	C3216NP0393JEP	1V, 1kHz	39	nF	±5%	1.60	±0.30	±0.30	0.10%		

● Class II: High Dielectric Constant Type

■ Feature

1. High volumetric efficiency
2. High insulation resistance
3. RoHS compliant
4. Halogen Free

■ Application

1. Blocking
2. Coupling
3. Timing
4. Bypassing
5. Frequency discriminating
6. Flittering

■ Part Number & Characteristic

■ X5R Series

● C0603X5R Series(EIA0201)

RV	DARFON P/N	DARFON P/N 2	Measuring Condition	Capacitance		Available Tolerance	Thick. (mm)	Tolerance(mm)		DF (max.)	Standard Packing	Test Spec.
				Value	Unit			L/W	Thick.			
50V	C0603X5R331KGT	C0603X5R331KGT	1V, 1kHz	330	pF	±10%	0.30	± 0.03	± 0.03	5.0%	Paper, 15Kpcs	(I)
	C0603X5R102□GTS	C0603X5R102□GT	1V, 1kHz	1.0	nF	±10%, ±20%	0.30	± 0.03	± 0.03	5.0%		(I)
	C0603X5R103KGT	C0603X5R103KGT	1V, 1kHz	10	nF	±10%	0.30	± 0.03	± 0.03	5.0%		(II)*
	C0603X5R104KGT	C0603X5R104KGT	1V, 1kHz	100	nF	±10%	0.30	± 0.03	± 0.03	10.0%		(II)*
35V	C0603X5R104KNTS	C0603X5R104KNT	1V, 1kHz	100	nF	±10%	0.30	± 0.03	± 0.03	10.0%	Paper, 15Kpcs	(II)
25V	C0603X5R101KFTS	C0603X5R101KFT	1V, 1kHz	100	pF	±10%	0.30	± 0.03	± 0.03	5.0%	Paper, 15Kpcs	(I)
	C0603X5R151KFTS	C0603X5R151KFT	1V, 1kHz	150	pF	±10%	0.30	± 0.03	± 0.03	5.0%		(I)
	C0603X5R221KFTS	C0603X5R221KFT	1V, 1kHz	220	pF	±10%	0.30	± 0.03	± 0.03	5.0%		(I)
	C0603X5R102□FTS	C0603X5R102□FT	1V, 1kHz	1.0	nF	±10%, ±20%	0.30	± 0.03	± 0.03	5.0%		(I)
	C0603X5R222KFTS	C0603X5R222KFT	1V, 1kHz	2.2	nF	±10%	0.30	± 0.03	± 0.03	5.0%		(I)
	C0603X5R472KFTS	C0603X5R472KFT	1V, 1kHz	4.7	nF	±10%	0.30	± 0.03	± 0.03	5.0%		(I)
	C0603X5R682KFTS	C0603X5R682KFT	1V, 1kHz	6.8	nF	±10%	0.30	± 0.03	± 0.03	5.0%		(I)
	C0603X5R103□FTS	C0603X5R103□FT	1V, 1kHz	10	nF	±10%, ±20%	0.30	± 0.03	± 0.03	5.0%		(II)*
	C0603X5R153□FTS	C0603X5R153□FT	1V, 1kHz	15	nF	±10%, ±20%	0.30	± 0.03	± 0.03	10.0%		(II)
	C0603X5R183□FTS	C0603X5R183□FT	1V, 1kHz	18	nF	±10%, ±20%	0.30	± 0.03	± 0.03	10.0%		(II)
	C0603X5R223□FTS	C0603X5R223□FT	1V, 1kHz	22	nF	±10%, ±20%	0.30	± 0.03	± 0.03	10.0%		(II)
	C0603X5R273□FTS	C0603X5R273□FT	1V, 1kHz	27	nF	±10%, ±20%	0.30	± 0.03	± 0.03	10.0%		(II)
	C0603X5R333□FTS	C0603X5R333□FT	1V, 1kHz	33	nF	±10%, ±20%	0.30	± 0.03	± 0.03	10.0%		(II)
	C0603X5R393□FTS	C0603X5R393□FT	1V, 1kHz	39	nF	±10%, ±20%	0.30	± 0.03	± 0.03	10.0%		(II)
	C0603X5R473□FTS	C0603X5R473□FT	1V, 1kHz	47	nF	±10%, ±20%	0.30	± 0.03	± 0.03	10.0%		(II)
	C0603X5R563□FTS	C0603X5R563□FT	1V, 1kHz	56	nF	±10%, ±20%	0.30	± 0.03	± 0.03	10.0%		(II)
	C0603X5R683□FTS	C0603X5R683□FT	1V, 1kHz	68	nF	±10%, ±20%	0.30	± 0.03	± 0.03	10.0%		(II)
	C0603X5R823□FTS	C0603X5R823□FT	1V, 1kHz	82	nF	±10%, ±20%	0.30	± 0.03	± 0.03	10.0%		(II)
	C0603X5R104□FTS	C0603X5R104□FT	1V, 1kHz	100	nF	±10%, ±20%	0.30	± 0.03	± 0.03	10.0%		(II)
	C0603X5R224□FTS	C0603X5R224□FT	1V, 1kHz	220	nF	±10%, ±20%	0.30	± 0.05	± 0.05	10.0%		(II)*
C0603X5R334□FTS	C0603X5R334□FT	1V, 1kHz	330	nF	±10%, ±20%	0.30	± 0.09	± 0.09	10.0%	(II)*		
C0603X5R474□FTS	C0603X5R474□FT	1V, 1kHz	470	nF	±10%, ±20%	0.30	± 0.09	± 0.09	10.0%	(II)*		
16V	C0603X5R102□ETS	C0603X5R102□ET	1V, 1kHz	1.0	nF	±10%, ±20%	0.30	± 0.03	± 0.03	5.0%	Paper, 15Kpcs	(I)
	C0603X5R222KETS	C0603X5R222KET	1V, 1kHz	2.2	nF	±10%	0.30	± 0.03	± 0.03	5.0%		(I)
	C0603X5R332KETS	C0603X5R332KET	1V, 1kHz	3.3	nF	±10%	0.30	± 0.03	± 0.03	5.0%		(II)
	C0603X5R472KETS	C0603X5R472KET	1V, 1kHz	4.7	nF	±10%	0.30	± 0.03	± 0.03	5.0%		(II)
	C0603X5R103□ETS	C0603X5R103□ET	1V, 1kHz	10	nF	±10%, ±20%	0.30	± 0.03	± 0.03	5.0%		(II)
	C0603X5R153□ETS	C0603X5R153□ET	1V, 1kHz	15	nF	±10%, ±20%	0.30	± 0.03	± 0.03	10.0%		(II)
	C0603X5R223□ETS	C0603X5R223□ET	1V, 1kHz	22	nF	±10%, ±20%	0.30	± 0.03	± 0.03	10.0%		(II)
	C0603X5R273□ETS	C0603X5R273□ET	1V, 1kHz	27	nF	±10%, ±20%	0.30	± 0.03	± 0.03	10.0%		(II)
	C0603X5R333□ETS	C0603X5R333□ET	1V, 1kHz	33	nF	±10%, ±20%	0.30	± 0.03	± 0.03	10.0%		(II)
	C0603X5R473□ETS	C0603X5R473□ET	1V, 1kHz	47	nF	±10%, ±20%	0.30	± 0.03	± 0.03	10.0%		(II)
	C0603X5R683□ETS	C0603X5R683□ET	1V, 1kHz	68	nF	±10%, ±20%	0.30	± 0.05	± 0.05	10.0%		(II)
	C0603X5R104□ETS	C0603X5R104□ET	1V, 1kHz	100	nF	±10%, ±20%	0.30	± 0.03	± 0.03	10.0%		(II)
	C0603X5R224□ETS	C0603X5R224□ET	1V, 1kHz	220	nF	±10%, ±20%	0.30	± 0.05	± 0.05	10.0%		(II)*
	C0603X5R334□ETS	C0603X5R334□ET	1V, 1kHz	330	nF	±10%, ±20%	0.30	± 0.09	± 0.09	10.0%		(II)*
	C0603X5R474□ETS	C0603X5R474□ET	1V, 1kHz	470	nF	±10%, ±20%	0.30	± 0.09	± 0.09	10.0%		(II)*
	C0603X5R105METS	C0603X5R105MET	0.5V, 1kHz	1.0	uF	±20%	0.30	± 0.09	± 0.09	12.5%		(II)*
10V	C0603X5R222□DTS	C0603X5R222□DT	1V, 1kHz	2.2	nF	±10%, ±20%	0.30	± 0.03	± 0.03	7.5%	Paper, 15Kpcs	(I)
	C0603X5R332□DTS	C0603X5R332□DT	1V, 1kHz	3.3	nF	±10%, ±20%	0.30	± 0.03	± 0.03	7.5%		(I)
	C0603X5R472□DTS	C0603X5R472□DT	1V, 1kHz	4.7	nF	±10%, ±20%	0.30	± 0.03	± 0.03	7.5%		(I)
	C0603X5R562□DTS	C0603X5R562□DT	1V, 1kHz	5.6	nF	±10%, ±20%	0.30	± 0.03	± 0.03	7.5%		(I)
	C0603X5R682□DTS	C0603X5R682□DT	1V, 1kHz	6.8	nF	±10%, ±20%	0.30	± 0.03	± 0.03	7.5%		(I)
	C0603X5R822□DTS	C0603X5R822□DT	1V, 1kHz	8.2	nF	±10%, ±20%	0.30	± 0.03	± 0.03	7.5%		(I)
	C0603X5R103□DTS	C0603X5R103□DT	1V, 1kHz	10	nF	±10%, ±20%	0.30	± 0.03	± 0.03	7.5%		(I)
	C0603X5R153□DTS	C0603X5R153□DT	1V, 1kHz	15	nF	±10%, ±20%	0.30	± 0.03	± 0.03	10.0%		(II)
	C0603X5R223□DTS	C0603X5R223□DT	1V, 1kHz	22	nF	±10%, ±20%	0.30	± 0.03	± 0.03	10.0%		(II)
	C0603X5R333□DTS	C0603X5R333□DT	1V, 1kHz	33	nF	±10%, ±20%	0.30	± 0.03	± 0.03	10.0%		(II)
	C0603X5R473□DTS	C0603X5R473□DT	1V, 1kHz	47	nF	±10%, ±20%	0.30	± 0.03	± 0.03	10.0%		(II)
	C0603X5R563□DTS	C0603X5R563□DT	1V, 1kHz	56	nF	±10%, ±20%	0.30	± 0.03	± 0.03	10.0%		(II)
	C0603X5R683□DTS	C0603X5R683□DT	1V, 1kHz	68	nF	±10%, ±20%	0.30	± 0.05	± 0.05	10.0%		(II)
	C0603X5R823□DTS	C0603X5R823□DT	1V, 1kHz	82	nF	±10%, ±20%	0.30	± 0.03	± 0.03	10.0%		(II)
	C0603X5R104□DTS	C0603X5R104□DT	1V, 1kHz	100	nF	±10%, ±20%	0.30	± 0.03	± 0.03	10.0%		(II)
	C0603X5R224□DTS	C0603X5R224□DT	1V, 1kHz	220	nF	±10%, ±20%	0.30	± 0.05	± 0.05	10.0%		(II)*
	C0603X5R334□DTS	C0603X5R334□DT	1V, 1kHz	330	nF	±10%, ±20%	0.30	± 0.09	± 0.09	12.5%		(II)*
	C0603X5R474□DTS	C0603X5R474□DT	1V, 1kHz	470	nF	±10%, ±20%	0.30	± 0.09	± 0.09	12.5%		(II)*

RV	DARFON P/N	DARFON P/N 2	Measuring Condition	Capacitance		Available Tolerance	Thick. (mm)	Tolerance(mm)		DF (max.)	Standard Packing	Test Spec.
				Value	Unit			L/W	Thick.			
10V	C0603X5R105□DTS	C0603X5R105□DT	0.5V , 1kHz	1.0	uF	±10% , ±20%	0.30	±0.09	±0.09	12.5%	Paper, 15Kpcs	(II)*
	C0603X5R225□DTS	C0603X5R225□DT	1V , 1kHz	2.2	uF	±10% , ±20%	0.30	±0.09	±0.09	15.0%		(II)*
6.3V	C0603X5R101KCTS	C0603X5R101KCT	1V , 1kHz	100	pF	±10%	0.30	± 0.03	± 0.03	5.0%	Paper, 15Kpcs	(I)
	C0603X5R222□CTS	C0603X5R222□CT	1V , 1kHz	2.2	nF	±10% , ±20%	0.30	± 0.03	± 0.03	10.0%		(I)
	C0603X5R332□CTS	C0603X5R332□CT	1V , 1kHz	3.3	nF	±10% , ±20%	0.30	± 0.03	± 0.03	10.0%		(I)
	C0603X5R472□CTS	C0603X5R472□CT	1V , 1kHz	4.7	nF	±10% , ±20%	0.30	± 0.03	± 0.03	10.0%		(I)
	C0603X5R562□CTS	C0603X5R562□CT	1V , 1kHz	5.6	nF	±10% , ±20%	0.30	± 0.03	± 0.03	10.0%		(I)
	C0603X5R682□CTS	C0603X5R682□CT	1V , 1kHz	6.8	nF	±10% , ±20%	0.30	± 0.03	± 0.03	10.0%		(I)
	C0603X5R822□CTS	C0603X5R822□CT	1V , 1kHz	8.2	nF	±10% , ±20%	0.30	± 0.03	± 0.03	10.0%		(I)
	C0603X5R103□CTS	C0603X5R103□CT	1V , 1kHz	10	nF	±10% , ±20%	0.30	± 0.03	± 0.03	10.0%		(I)
	C0603X5R153□CTS	C0603X5R153□CT	1V , 1kHz	15	nF	±10% , ±20%	0.30	± 0.03	± 0.03	10.0%		(II)
	C0603X5R223□CTS	C0603X5R223□CT	1V , 1kHz	22	nF	±10% , ±20%	0.30	± 0.03	± 0.03	10.0%		(II)
	C0603X5R333□CTS	C0603X5R333□CT	1V , 1kHz	33	nF	±10% , ±20%	0.30	± 0.03	± 0.03	10.0%		(II)
	C0603X5R473□CTS	C0603X5R473□CT	1V , 1kHz	47	nF	±10% , ±20%	0.30	± 0.03	± 0.03	10.0%		(II)
	C0603X5R563□CTS	C0603X5R563□CT	1V , 1kHz	56	nF	±10% , ±20%	0.30	± 0.03	± 0.03	10.0%		(II)
	C0603X5R683□CTS	C0603X5R683□CT	1V , 1kHz	68	nF	±10% , ±20%	0.30	± 0.03	± 0.03	10.0%		(II)
	C0603X5R823□CTS	C0603X5R823□CT	1V , 1kHz	82	nF	±10% , ±20%	0.30	± 0.03	± 0.03	10.0%		(II)
	C0603X5R104□CTS	C0603X5R104□CT	1V , 1kHz	100	nF	±10% , ±20%	0.30	± 0.03	± 0.03	10.0%		(II)
	C0603X5R224□CTS	C0603X5R224□CT	1V , 1kHz	220	nF	±10% , ±20%	0.30	± 0.05	± 0.05	10.0%		(II)*
	C0603X5R334□CTS	C0603X5R334□CT	1V , 1kHz	330	nF	±10% , ±20%	0.30	± 0.05	± 0.05	10.0%		(II)*
	C0603X5R474□CTS	C0603X5R474□CT	1V , 1kHz	470	nF	±10% , ±20%	0.30	±0.09	±0.09	12.5%		(II)*
	C0603X5R105□CTS	C0603X5R105□CT	1V , 1kHz	1.0	uF	±10% , ±20%	0.30	±0.05	±0.05	12.5%		(II)*
C0603X5R225MCTS	C0603X5R225MCT	0.5V , 1kHz	2.2	uF	±20%	0.30	±0.09	±0.09	20.0%	(II)*		
C0603X5R475MCTSB		0.5V , 1kHz	4.7	uF	±20%	0.50	±0.09	±0.05	20.0%	Paper, 10Kpcs	(II)*	
4V	C0603X5R473□BTS	C0603X5R473□BT	1V , 1kHz	47	nF	±10% , ±20%	0.30	± 0.03	± 0.03	10.0%	Paper, 15Kpcs	(II)
	C0603X5R474□BTS	C0603X5R474□BT	1V , 1kHz	470	nF	±10% , ±20%	0.30	±0.09	±0.09	12.5%		(II)*
	C0603X5R105□BTS	C0603X5R105□BT	0.5V , 1kHz	1.0	uF	±10% , ±20%	0.30	±0.05	±0.05	10.0%		(II)*
	C0603X5R225MBTS	C0603X5R225MBT	0.5V , 1kHz	2.2	uF	±20%	0.30	±0.09	±0.09	20.0%		(II)*
2.5V	C0603X5R475MBTSB		0.5V , 1kHz	4.7	uF	±20%	0.50	±0.09	±0.05	20.0%	Paper, 10Kpcs	(II)*
	C0603X5R475MTTBS		0.5V , 1kHz	4.7	uF	±20%	0.50	±0.09	±0.05	20.0%	Paper, 10Kpcs	(II)*

□ Tolerance Code: K=±10%, M=±20% ;Special tolerance on the request.

(II)* High temperature load life test are applicable in rated voltage *100%. (II)/(II)* are applied with derating voltage.

● C1005X5R Series (EIA0402)

RV	DARFON P/N	DARFON P/N 2	Measuring Condition	Capacitance		Available Tolerance	Thick. (mm)	Tolerance(mm)		DF (max.)	Standard Packing	Test Spec.
				Value	Unit			L/W	Thick.			
50V	C1005X5R102KGT	C1005X5R102KGT	1V, 1kHz	1.0	nF	±10%	0.50	±0.05	±0.05	5.0%	Paper, 10Kpcs	(I)
	C1005X5R682KGT	C1005X5R682KGT	1V, 1kHz	6.8	nF	±10%	0.50	±0.05	±0.05	5.0%		(I)
	C1005X5R103KGT	C1005X5R103KGT	1V, 1kHz	10	nF	±10%	0.50	±0.05	±0.05	5.0%		(I)
	C1005X5R183KGT	C1005X5R183KGT	1V, 1kHz	18	nF	±10%	0.50	±0.05	±0.05	5.0%		(I)
	C1005X5R223KGT	C1005X5R223KGT	1V, 1kHz	22	nF	±10%	0.50	±0.05	±0.05	5.0%		(I)
	C1005X5R333KGT	C1005X5R333KGT	1V, 1kHz	33	nF	±10%	0.50	±0.05	±0.05	5.0%		(I)
	C1005X5R473KGT	C1005X5R473KGT	1V, 1kHz	47	nF	±10%	0.50	±0.05	±0.05	5.0%		(I)
	C1005X5R104□GTS	C1005X5R104□GT	1V, 1kHz	100	nF	±5%, ±10%, ±20%	0.50	±0.05	±0.05	10.0%		(II)
	C1005X5R224KGT	C1005X5R224KGT	1V, 1kHz	220	nF	±10%	0.50	±0.10	±0.10	10.0%		(III)
	C1005X5R334□GTS	C1005X5R334□GT	1V, 1kHz	330	nF	±10%, ±20%	0.50	±0.10	±0.10	10.0%		(III)*
C1005X5R474□GTS	C1005X5R474□GT	1V, 1kHz	470	nF	±10%, ±20%	0.50	±0.10	±0.10	10.0%	(III)*		
C1005X5R105□GTS	C1005X5R105□GT	1V, 1kHz	1.0	uF	±10%, ±20%	0.50	±0.20	±0.20	10.0%	(III)*		
35V	C1005X5R104□NTS	C1005X5R104□NT	1V, 1kHz	100	nF	±10%, ±20%	0.50	±0.05	±0.05	10.0%	Paper, 10Kpcs	(II)
	C1005X5R105□NTS	C1005X5R105□NT	1V, 1kHz	1.0	uF	±10%, ±20%	0.50	±0.10	±0.10	10.0%		(III)*
	C1005X5R225□NTS	C1005X5R225□NT	1V, 1kHz	2.2	uF	±10%, ±20%	0.50	±0.20	±0.20	10.0%		(III)*
25V	C1005X5R103KFTS	C1005X5R103KFT	1V, 1kHz	10	nF	±10%	0.50	±0.05	±0.05	5.0%	Paper, 10Kpcs	(I)
	C1005X5R223□FTS	C1005X5R223□FT	1V, 1kHz	22	nF	±10%, ±20%	0.50	±0.05	±0.05	5.0%		(I)
	C1005X5R333KFTS	C1005X5R333KFT	1V, 1kHz	33	nF	±10%	0.50	±0.05	±0.05	5.0%		(I)
	C1005X5R473KFTS	C1005X5R473KFT	1V, 1kHz	47	nF	±10%	0.50	±0.05	±0.05	5.0%		(I)
	C1005X5R683KFTS	C1005X5R683KFT	1V, 1kHz	68	nF	±10%	0.50	±0.05	±0.05	5.0%		(I)
	C1005X5R104□FTS	C1005X5R104□FT	1V, 1kHz	100	nF	±10%, ±20%	0.50	±0.05	±0.05	5.0%		(I)
	C1005X5R224□FTS	C1005X5R224□FT	1V, 1kHz	220	nF	±10%, ±20%	0.50	±0.05	±0.05	10.0%		(II)
	C1005X5R334□FTS	C1005X5R334□FT	1V, 1kHz	330	nF	±10%, ±20%	0.50	±0.05	±0.05	12.5%		(II)
	C1005X5R394□FTS	C1005X5R394□FT	1V, 1kHz	390	nF	±10%, ±20%	0.50	±0.05	±0.05	12.5%		(II)
	C1005X5R474□FTS	C1005X5R474□FT	1V, 1kHz	470	nF	±10%, ±20%	0.50	±0.20	±0.20	12.5%		(II)
	C1005X5R564□FTS	C1005X5R564□FT	1V, 1kHz	560	nF	±10%, ±20%	0.50	±0.10	±0.10	12.5%		(III)*
	C1005X5R684□FTS	C1005X5R684□FT	1V, 1kHz	680	nF	±10%, ±20%	0.50	±0.10	±0.10	12.5%		(III)*
	C1005X5R105□FTS	C1005X5R105□FT	1V, 1kHz	1.0	uF	±10%, ±20%	0.50	±0.10	±0.10	12.5%		(III)*
	C1005X5R225□FTS	C1005X5R225□FT	1V, 1kHz	2.2	uF	±10%, ±20%	0.50	±0.20	±0.20	12.5%		(III)*
	C1005X5R475MFTS	C1005X5R475MFT	1V, 1kHz	4.7	uF	±20%	0.50	±0.20	±0.20	12.5%		(III)*
16V	C1005X5R102KETS	C1005X5R102KET	1V, 1kHz	1.0	nF	±10%	0.50	±0.05	±0.05	5.0%	Paper, 10Kpcs	(I)
	C1005X5R153□ETS	C1005X5R153□ET	1V, 1kHz	15	nF	±5%, ±10%, ±20%	0.50	±0.05	±0.05	5.0%		(I)
	C1005X5R223□ETS	C1005X5R223□ET	1V, 1kHz	22	nF	±10%, ±20%	0.50	±0.05	±0.05	5.0%		(I)
	C1005X5R273□ETS	C1005X5R273□ET	1V, 1kHz	27	nF	±10%, ±20%	0.50	±0.05	±0.05	5.0%		(I)
	C1005X5R333□ETS	C1005X5R333□ET	1V, 1kHz	33	nF	±10%, ±20%	0.50	±0.05	±0.05	5.0%		(I)
	C1005X5R393KETS	C1005X5R393KET	1V, 1kHz	39	nF	±10%	0.50	±0.05	±0.05	5.0%		(I)
	C1005X5R473□ETS	C1005X5R473□ET	1V, 1kHz	47	nF	±10%, ±20%	0.50	±0.05	±0.05	5.0%		(I)
	C1005X5R563□ETS	C1005X5R563□ET	1V, 1kHz	56	nF	±10%, ±20%	0.50	±0.05	±0.05	5.0%		(I)
	C1005X5R683□ETS	C1005X5R683□ET	1V, 1kHz	68	nF	±10%, ±20%	0.50	±0.05	±0.05	5.0%		(I)
	C1005X5R823□ETS	C1005X5R823□ET	1V, 1kHz	82	nF	±10%, ±20%	0.50	±0.05	±0.05	5.0%		(I)
	C1005X5R104□ETS	C1005X5R104□ET	1V, 1kHz	100	nF	±10%, ±20%	0.50	±0.05	±0.05	5.0%		(I)
	C1005X5R124□ETS	C1005X5R124□ET	1V, 1kHz	120	nF	±10%, ±20%	0.50	±0.05	±0.05	7.5%		(II)
	C1005X5R154□ETS	C1005X5R154□ET	1V, 1kHz	150	nF	±10%, ±20%	0.50	±0.05	±0.05	7.5%		(II)
	C1005X5R184□ETS	C1005X5R184□ET	1V, 1kHz	180	nF	±10%, ±20%	0.50	±0.05	±0.05	7.5%		(II)
	C1005X5R224□ETS	C1005X5R224□ET	1V, 1kHz	220	nF	±10%, ±20%	0.50	±0.05	±0.05	10.0%		(II)
	C1005X5R334□ETS	C1005X5R334□ET	1V, 1kHz	330	nF	±10%, ±20%	0.50	±0.05	±0.05	12.5%		(II)
	C1005X5R474□ETS	C1005X5R474□ET	1V, 1kHz	470	nF	±10%, ±20%	0.50	±0.10	±0.10	12.5%		(II)
	C1005X5R564□ETS	C1005X5R564□ET	1V, 1kHz	560	nF	±10%, ±20%	0.50	±0.05	±0.05	12.5%		(II)
	C1005X5R684□ETS	C1005X5R684□ET	1V, 1kHz	680	nF	±10%, ±20%	0.50	±0.05	±0.05	12.5%		(II)
	C1005X5R105□ETS	C1005X5R105□ET	1V, 1kHz	1.0	uF	±10%, ±20%	0.50	±0.05	±0.05	12.5%		(II)
C1005X5R225□ETS	C1005X5R225□ET	1V, 1kHz	2.2	uF	±10%, ±20%	0.50	±0.20	±0.20	12.5%	(III)*		
C1005X5R475METS	C1005X5R475MET	1V, 1kHz	4.7	uF	±20%	0.50	±0.20	±0.20	12.5%	(III)*		
10V	C1005X5R102□DTS	C1005X5R102□DT	1V, 1kHz	1.0	nF	±10%, ±20%	0.50	±0.05	±0.05	5.0%	Paper, 10Kpcs	(I)
	C1005X5R103KDTS	C1005X5R103KDT	1V, 1kHz	10	nF	±10%	0.50	±0.05	±0.05	7.5%		(I)
	C1005X5R153□DTS	C1005X5R153□DT	1V, 1kHz	15	nF	±10%, ±20%	0.50	±0.05	±0.05	7.5%		(I)
	C1005X5R223□DTS	C1005X5R223□DT	1V, 1kHz	22	nF	±10%, ±20%	0.50	±0.05	±0.05	7.5%		(I)
	C1005X5R333□DTS	C1005X5R333□DT	1V, 1kHz	33	nF	±10%, ±20%	0.50	±0.05	±0.05	7.5%		(I)
	C1005X5R473□DTS	C1005X5R473□DT	1V, 1kHz	47	nF	±10%, ±20%	0.50	±0.05	±0.05	7.5%		(I)
	C1005X5R563□DTS	C1005X5R563□DT	1V, 1kHz	56	nF	±10%, ±20%	0.50	±0.05	±0.05	7.5%		(I)
	C1005X5R683□DTS	C1005X5R683□DT	1V, 1kHz	68	nF	±10%, ±20%	0.50	±0.05	±0.05	7.5%		(I)
	C1005X5R823□DTS	C1005X5R823□DT	1V, 1kHz	82	nF	±10%, ±20%	0.50	±0.05	±0.05	7.5%		(I)
	C1005X5R104□DTS	C1005X5R104□DT	1V, 1kHz	100	nF	±10%, ±20%	0.50	±0.05	±0.05	7.5%		(I)
	C1005X5R124□DTS	C1005X5R124□DT	1V, 1kHz	120	nF	±10%, ±20%	0.50	±0.05	±0.05	7.5%		(II)
	C1005X5R154□DTS	C1005X5R154□DT	1V, 1kHz	150	nF	±10%, ±20%	0.50	±0.05	±0.05	7.5%		(II)
	C1005X5R184□DTS	C1005X5R184□DT	1V, 1kHz	180	nF	±10%, ±20%	0.50	±0.05	±0.05	7.5%		(II)
	C1005X5R224□DTS	C1005X5R224□DT	1V, 1kHz	220	nF	±10%, ±20%	0.50	±0.05	±0.05	7.5%		(II)
	C1005X5R334□DTS	C1005X5R334□DT	1V, 1kHz	330	nF	±10%, ±20%	0.50	±0.05	±0.05	10.0%		(II)
	C1005X5R394□DTS	C1005X5R394□DT	1V, 1kHz	390	nF	±10%, ±20%	0.50	±0.05	±0.05	10.0%		(II)
	C1005X5R474□DTS	C1005X5R474□DT	1V, 1kHz	470	nF	±10%, ±20%	0.50	±0.05	±0.05	10.0%		(II)
	C1005X5R684□DTS	C1005X5R684□DT	1V, 1kHz	680	nF	±10%, ±20%	0.50	±0.05	±0.05	10.0%		(II)
	C1005X5R105□DTS	C1005X5R105□DT	1V, 1kHz	1.0	uF	±10%, ±20%	0.50	±0.05	±0.05	10.0%		(II)
	C1005X5R225□DTS	C1005X5R225□DT	1V, 1kHz	2.2	uF	±10%, ±20%	0.50	±0.20	±0.20	10.0%		(III)*
	C1005X5R475□DTS	C1005X5R475□DT	1V, 1kHz	4.7	uF	±10%, ±20%	0.50	±0.15	±0.15	12.5%		(III)*
	C1005X5R106MDTS	C1005X5R106MDT	0.5V, 1kHz	10	uF	±20%	0.50	±0.20	±0.20	12.5%		(III)*
C1005X5R226MDTS	C1005X5R226MDT	0.5V, 120Hz	22	uF	±20%	0.50	±0.30	±0.30	20.0%	(III)*		

MLCC
General Purpose

RV	DARFON P/N	DARFON P/N 2	Measuring Condition	Capacitance		Available Tolerance	Thick. (mm)	Tolerance(mm)		DF (max.)	Standard Packing	Test Spec.
				Value	Unit			L/W	Thick.			
6.3V	C1005X5R223KCTS	C1005X5R223KCT	1V , 1kHz	22	nF	±10%	0.50	±0.05	±0.05	7.5%	Paper, 10Kpcs	(I)
	C1005X5R473KCTS	C1005X5R473KCT	1V , 1kHz	47	nF	±10%	0.50	±0.05	±0.05	7.5%		(I)
	C1005X5R104□CTS	C1005X5R104□CT	1V , 1kHz	100	nF	±10% , ±20%	0.50	±0.05	±0.05	10.0%		(I)
	C1005X5R224□CTS	C1005X5R224□CT	1V , 1kHz	220	nF	±10% , ±20%	0.50	±0.05	±0.05	10.0%		(II)
	C1005X5R334□CTS	C1005X5R334□CT	1V , 1kHz	330	nF	±10% , ±20%	0.50	±0.05	±0.05	10.0%		(II)
	C1005X5R474□CTS	C1005X5R474□CT	1V , 1kHz	470	nF	±10% , ±20%	0.50	±0.05	±0.05	10.0%		(II)
	C1005X5R684□CTS	C1005X5R684□CT	1V , 1kHz	680	nF	±10% , ±20%	0.50	±0.05	±0.05	10.0%	(II)	
	C1005X5R105MCTSA		1V , 1kHz	1.0	uF	±20%	0.30	±0.05	±0.03	12.5%	Paper, 15Kpcs	(II)*
	C1005X5R105□CTS	C1005X5R105□CT	0.5V , 1kHz	1.0	uF	±10% , ±20%	0.50	±0.05	±0.05	10.0%	Paper, 10Kpcs	(II)
	C1005X5R225MCTSA		0.5V , 1kHz	2.2	uF	±20%	0.30	±0.05	±0.03	10.0%	Paper, 15Kpcs	(II)*
	C1005X5R225□CTS	C1005X5R225□CT	1V , 1kHz	2.2	uF	±10% , ±20%	0.50	±0.20	±0.20	10.0%	Paper, 10Kpcs	(II)*
	C1005X5R475MCTSA		0.5V , 1kHz	4.7	uF	±20%	0.30	±0.20	±0.03	10.0%	Paper, 15Kpcs	(II)*
	C1005X5R475□CTS	C1005X5R475□CT	0.5V , 1kHz	4.7	uF	±10% , ±20%	0.50	±0.15	±0.15	10.0%		(II)*
	C1005X5R106MCTS	C1005X5R106MCT	0.5V , 1kHz	10	uF	±20%	0.50	±0.20	±0.20	15.0%	Paper, 10Kpcs	(II)
C1005X5R226MCTS	C1005X5R226MCT	0.5V , 120Hz	22	uF	±20%	0.50	±0.20	±0.20	20.0%		(II)*	
4V	C1005X5R105□BTS	C1005X5R105□BT	1V , 1kHz	1.0	uF	±10% , ±20%	0.50	±0.05	±0.05	15.0%	Paper, 10Kpcs	(II)
	C1005X5R225□BTS	C1005X5R225□BT	1V , 1kHz	2.2	uF	±10% , ±20%	0.50	±0.20	±0.20	10.0%		(II)
	C1005X5R225MBTSA		0.5V , 1kHz	2.2	uF	±20%	0.30	±0.05	±0.03	10.0%	Paper, 15Kpcs	(II)
	C1005X5R475□BTS	C1005X5R475□BT	0.5V , 1kHz	4.7	uF	±10% , ±20%	0.50	±0.15	±0.15	10.0%		(II)
	C1005X5R106MBTS	C1005X5R106MBT	0.5V , 1kHz	10	uF	±20%	0.50	±0.20	±0.20	15.0%	Paper, 10Kpcs	(II)
	C1005X5R226MBTS	C1005X5R226MBT	0.5V , 120Hz	22	uF	±20%	0.50	±0.20	±0.20	15.0%		(II)*

□ Tolerance Code: K=±10%, M=±20% ;Special tolerance on the request.

(II)* High temperature load life test are applicable in rated voltage *100%. (II)/(II)* are applied with derating voltage.

● C1608X5R Series (EIA0603)

RV	DARFON P/N	DARFON P/N 2	Measuring Condition	Capacitance		Available Tolerance	Thick. (mm)	Tolerance(mm)		DF (max.)	Standard Packing	Test Spec.
				Value	Unit			L/W	Thick.			
50V	C1608X5R102KGTS	C1608X5R102KGT	1V, 1kHz	1.0	nF	±10%	0.80	±0.10	±0.10	5.0%	Paper, 4Kpcs	(I)
	C1608X5R103KGTS	C1608X5R103KGT	1V, 1kHz	10	nF	±10%	0.80	±0.10	±0.10	5.0%		(I)
	C1608X5R333KGTS	C1608X5R333KGT	1V, 1kHz	33	nF	±10%	0.80	±0.15	±0.15	5.0%		(I)
	C1608X5R104□GTS	C1608X5R104□GT	1V, 1kHz	100	nF	±10%, ±20%	0.80	±0.15	±0.15	5.0%		(II)
	C1608X5R224□GTS	C1608X5R224□GT	1V, 1kHz	220	nF	±10%, ±20%	0.80	±0.15	±0.15	5.0%		(II)
	C1608X5R474□GTS	C1608X5R474□GT	1V, 1kHz	470	nF	±10%, ±20%	0.80	±0.15	±0.15	10.0%		(II)
	C1608X5R105□GTS	C1608X5R105□GT	1V, 1kHz	1.0	uF	±10%, ±20%	0.80	±0.20	±0.20	10.0%		(II)
35V	C1608X5R225□GTS	C1608X5R225□GT	1V, 1kHz	2.2	uF	±10%, ±20%	0.80	±0.20	±0.20	10.0%	Paper, 4Kpcs	(III)
	C1608X5R105□NTS	C1608X5R105□NT	1V, 1kHz	1.0	uF	±10%, ±20%	0.80	±0.10	±0.10	10.0%		(II)*
	C1608X5R225□NTS	C1608X5R225□NT	1V, 1kHz	2.2	uF	±10%, ±20%	0.80	±0.10	±0.10	10.0%		(II)*
	C1608X5R475□NTS	C1608X5R475□NT	1V, 1kHz	4.7	uF	±10%, ±20%	0.80	±0.20	±0.20	10.0%		(II)*
25V	C1608X5R106MNTS	C1608X5R106MNT	1V, 1kHz	10	uF	±20%	0.80	±0.20	±0.20	10.0%	Paper, 4Kpcs	(III)*
	C1608X5R104□FTS	C1608X5R104□FT	1V, 1kHz	100	nF	±10%, ±20%	0.80	±0.10	±0.10	5.0%		(I)
	C1608X5R224□FTS	C1608X5R224□FT	1V, 1kHz	220	nF	±10%, ±20%	0.80	±0.10	±0.10	5.0%		(I)
	C1608X5R334KFTS	C1608X5R334KFT	1V, 1kHz	330	nF	±10%	0.80	±0.15	±0.15	7.5%		(I)
	C1608X5R474□FTS	C1608X5R474□FT	1V, 1kHz	470	nF	±5%, ±10%, ±20%	0.80	±0.10	±0.10	5.0%		(II)
	C1608X5R684KFTS	C1608X5R684KFT	1V, 1kHz	680	nF	±10%	0.80	±0.15	±0.15	7.5%		(II)
	C1608X5R105□FTS	C1608X5R105□FT	1V, 1kHz	1.0	uF	±10%, ±20%	0.80	±0.15	±0.15	10.0%		(II)
	C1608X5R105□FTSB		1V, 1kHz	1.0	uF	±10%, ±20%	0.50	±0.10	+0/-0.10	12.5%		(III)*
	C1608X5R225□FTS	C1608X5R225□FT	1V, 1kHz	2.2	uF	±10%, ±20%	0.80	±0.15	±0.15	10.0%		(II)
	C1608X5R335□FTS	C1608X5R335□FT	1V, 1kHz	3.3	uF	±10%, ±20%	0.80	±0.20	±0.20	10.0%		(II)
	C1608X5R475□FTS	C1608X5R475□FT	1V, 1kHz	4.7	uF	±10%, ±20%	0.80	±0.20	±0.20	10.0%		(II)
	C1608X5R106□FTS	C1608X5R106□FT	1V, 1kHz	10	uF	±10%, ±20%	0.80	±0.20	±0.20	10.0%		(III)*
	16V	C1608X5R104□ETS	C1608X5R104□ET	1V, 1kHz	100	nF	±10%, ±20%	0.80	±0.10	±0.10		5.0%
C1608X5R224□ETS		C1608X5R224□ET	1V, 1kHz	220	nF	±10%, ±20%	0.80	±0.10	±0.10	5.0%	(I)	
C1608X5R334□ETS		C1608X5R334□ET	1V, 1kHz	330	nF	±10%, ±20%	0.80	±0.10	±0.10	5.0%	(I)	
C1608X5R474□ETS		C1608X5R474□ET	1V, 1kHz	470	nF	±10%, ±20%	0.80	±0.10	±0.10	3.5%	(II)	
C1608X5R684□ETS		C1608X5R684□ET	1V, 1kHz	680	nF	±10%, ±20%	0.80	±0.10	±0.10	7.5%	(II)	
C1608X5R105□ETS		C1608X5R105□ET	1V, 1kHz	1.0	uF	±10%, ±20%	0.80	±0.10	±0.10	10.0%	(II)	
C1608X5R105□ETSB			0.5V, 1kHz	1.0	uF	±10%, ±20%	0.50	±0.10	+0/-0.10	10.0%	(III)	
C1608X5R225□ETS		C1608X5R225□ET	1V, 1kHz	2.2	uF	±10%, ±20%	0.80	±0.15	±0.15	10.0%	(II)	
C1608X5R335□ETS		C1608X5R335□ET	1V, 1kHz	3.3	uF	±10%, ±20%	0.80	±0.15	±0.15	10.0%	(III)*	
C1608X5R475□ETS		C1608X5R475□ET	1V, 1kHz	4.7	uF	±10%, ±20%	0.80	±0.15	±0.15	10.0%	(III)*	
C1608X5R106□ETS		C1608X5R106□ET	1V, 1kHz	10	uF	±10%, ±20%	0.80	±0.20	±0.20	10.0%	(III)*	
10V	C1608X5R226METS	C1608X5R226MET	0.5V, 120Hz	22	uF	±20%	0.80	±0.20	±0.20	10.0%	Paper, 4Kpcs	(II)*
	C1608X5R104□DTS	C1608X5R104□DT	1V, 1kHz	100	nF	±10%, ±20%	0.80	±0.10	±0.10	7.5%		(I)
	C1608X5R224□DTS	C1608X5R224□DT	1V, 1kHz	220	nF	±10%, ±20%	0.80	±0.10	±0.10	7.5%		(I)
	C1608X5R334□DTS	C1608X5R334□DT	1V, 1kHz	330	nF	±10%, ±20%	0.80	±0.10	±0.10	7.5%		(I)
	C1608X5R474□DTS	C1608X5R474□DT	1V, 1kHz	470	nF	±10%, ±20%	0.80	±0.10	±0.10	7.5%		(I)
	C1608X5R684□DTS	C1608X5R684□DT	1V, 1kHz	680	nF	±10%, ±20%	0.80	±0.10	±0.10	7.5%		(I)
	C1608X5R105□DTS	C1608X5R105□DT	1V, 1kHz	1.0	uF	±10%, ±20%	0.80	±0.10	±0.10	7.5%		(II)
	C1608X5R105□DTSB		1V, 1kHz	1.0	uF	±10%, ±20%	0.50	±0.10	+0/-0.10	10.0%		(II)
	C1608X5R225□DTS	C1608X5R225□DT	1V, 1kHz	2.2	uF	±10%, ±20%	0.80	±0.15	±0.15	10.0%		(III)
	C1608X5R225□DTSB		0.5V, 1kHz	2.2	uF	±10%, ±20%	0.50	±0.10	+0/-0.10	10.0%		(III)*
	C1608X5R335□DTS	C1608X5R335□DT	1V, 1kHz	3.3	uF	±10%, ±20%	0.80	±0.15	±0.15	10.0%		(II)
	C1608X5R475□DTS	C1608X5R475□DT	1V, 1kHz	4.7	uF	±10%, ±20%	0.80	±0.15	±0.15	10.0%		(II)
	C1608X5R475□DTSB		1V, 1kHz	4.7	uF	±10%, ±20%	0.50	±0.20	±0.05	10.0%		(II)
	C1608X5R106□DTS	C1608X5R106□DT	1V, 1kHz	10	uF	±10%, ±20%	0.80	±0.20	±0.20	10.0%		(III)*
	C1608X5R226MDTS	C1608X5R226MDT	0.5V, 120Hz	22	uF	±20%	0.80	±0.25	±0.25	15.0%		(III)*
6.3V	C1608X5R226MDWS	C1608X5R226MDW	0.5V, 120Hz	22	uF	±20%	0.80	±0.20	±0.20	10.0%	Embossed, 4Kpcs	(III)*
	C1608X5R104□CTS	C1608X5R104□CT	1V, 1kHz	100	nF	±10%, ±20%	0.80	±0.10	±0.10	7.5%		(I)
	C1608X5R105□CTS	C1608X5R105□CT	1V, 1kHz	1.0	uF	±10%, ±20%	0.80	±0.10	±0.10	7.5%		(II)
	C1608X5R225□CTS	C1608X5R225□CT	1V, 1kHz	2.2	uF	±10%, ±20%	0.80	±0.15	±0.15	10.0%		(II)
	C1608X5R335□CTS	C1608X5R335□CT	1V, 1kHz	3.3	uF	±10%, ±20%	0.80	±0.15	±0.15	10.0%		(II)
	C1608X5R475□CTS	C1608X5R475□CT	1V, 1kHz	4.7	uF	±10%, ±20%	0.80	±0.15	±0.15	10.0%		(II)
	C1608X5R106MCTSB		0.5V, 1kHz	10	uF	±20%	0.50	±0.10	±0.10	10.0%		(III)*
	C1608X5R106□CTS	C1608X5R106□CT	1V, 1kHz	10	uF	±10%, ±20%	0.80	±0.15	±0.15	10.0%		(III)*
	C1608X5R226MCTS	C1608X5R226MCT	0.5V, 120Hz	22	uF	±20%	0.80	±0.20	±0.20	15.0%		(III)*
	C1608X5R476MCTS	C1608X5R476MCT	0.5V, 120Hz	47	uF	±20%	0.80	±0.20	±0.20	12.5%		(III)*
	4V	C1608X5R106MBTS	C1608X5R106MBT	1V, 1kHz	10	uF	±20%	0.80	±0.10	±0.10		10.0%
C1608X5R226MBTS		C1608X5R226MBT	0.5V, 120Hz	22	uF	±20%	0.80	±0.20	±0.20	10.0%	(III)*	
C1608X5R476MBTS		C1608X5R476MBT	0.5V, 120Hz	47	uF	±20%	0.80	±0.20	±0.20	12.5%	(III)*	

□ Tolerance Code: K=±10%, M=±20% ;Special tolerance on the request.

(II)* High temperature load life test are applicable in rated voltage *100%. (II)/(II)* are applied with derating voltage.

● C2012X5R Series (EIA0805)

RV	DARFON P/N	DARFON P/N 2	Measuring Condition	Capacitance		Available Tolerance	Thick. (mm)	Tolerance(mm)		DF (max.)	Standard Packing	Test Spec.
				Value	Unit			L/W	Thick.			
50V	C2012X5R224KGTS	C2012X5R224KGT	1V, 1kHz	220	nF	±10%	0.85	±0.15	±0.15	10.0%	Paper, 4Kpcs	(II)
	C2012X5R105□GTS	C2012X5R105□GT	1V, 1kHz	1.0	uF	±10%, ±20%	0.85	±0.15	±0.15	10.0%		(II)
	C2012X5R105□GPS	C2012X5R105□GP	1V, 1kHz	1.0	uF	±10%, ±20%	1.25	±0.15	±0.20	10.0%	Embossed, 3Kpcs	(II)
	C2012X5R225□GTS	C2012X5R225□GT	1V, 1kHz	2.2	uF	±10%, ±20%	0.85	±0.20	±0.15	10.0%	Paper, 4Kpcs	(II)
	C2012X5R225□GPS	C2012X5R225□GP	1V, 1kHz	2.2	uF	±10%, ±20%	1.25	±0.15/±0.20	±0.20	10.0%		(II)
	C2012X5R475□GPS	C2012X5R475□GP	1V, 1kHz	4.7	uF	±10%, ±20%	1.25	±0.20	±0.20	10.0%	Embossed, 3Kpcs	(II)*
35V	C2012X5R106□NPS	C2012X5R106□NP	1V, 1kHz	10	uF	±10%, ±20%	1.25	±0.20	±0.20	10.0%	Embossed, 3Kpcs	(II)*
	C2012X5R226MNPWS	C2012X5R226MNPW	0.5V, 120Hz	22	uF	±20%	1.25	±0.20	±0.20	15.0%	Embossed, 2Kpcs	(II)*
25V	C2012X5R474□FPS	C2012X5R474□FP	1V, 1kHz	470	nF	±10%, ±20%	1.25	±0.15/±0.20	±0.20	5.0%	Embossed, 3Kpcs	(I)
	C2012X5R105□FTS	C2012X5R105□FT	1V, 1kHz	1.0	uF	±10%, ±20%	0.85	±0.15	±0.10	10.0%	Paper, 4Kpcs	(II)
	C2012X5R105□FPS	C2012X5R105□FP	1V, 1kHz	1.0	uF	±10%, ±20%	1.25	±0.20	±0.20	10.0%	Embossed, 3Kpcs	(I)
	C2012X5R225□FTS	C2012X5R225□FT	1V, 1kHz	2.2	uF	±10%, ±20%	0.85	±0.20	±0.10	10.0%	Paper, 4Kpcs	(II)
	C2012X5R225□FPS	C2012X5R225□FP	1V, 1kHz	2.2	uF	±10%, ±20%	1.25	±0.15/±0.20	±0.20	10.0%	Embossed, 3Kpcs	(II)
	C2012X5R475□FTS	C2012X5R475□FT	1V, 1kHz	4.7	uF	±10%, ±20%	0.85	±0.20	±0.10	10.0%	Paper, 4Kpcs	(II)*
	C2012X5R475□FPS	C2012X5R475□FP	1V, 1kHz	4.7	uF	±10%, ±20%	1.25	±0.15/±0.20	±0.20	10.0%	Embossed, 3Kpcs	(II)
	C2012X5R106□FTS	C2012X5R106□FT	1V, 1kHz	10	uF	±10%, ±20%	0.85	±0.20	±0.10	12.5%	Paper, 4Kpcs	(II)*
	C2012X5R106□FPS	C2012X5R106□FP	1V, 1kHz	10	uF	±10%, ±20%	1.25	±0.20	±0.20	12.5%		(II)*
	C2012X5R226MFPS	C2012X5R226MFP	0.5V, 120Hz	22	uF	±20%	1.25	±0.20	±0.20	15.0%	Embossed, 3Kpcs	(II)*
	C2012X5R226MFW	C2012X5R226MFW	0.5V, 120Hz	22	uF	±20%	1.25	±0.20	±0.20	15.0%	Embossed, 2Kpcs	(II)*
	16V	C2012X5R105□ETS	C2012X5R105□ET	1V, 1kHz	1.0	uF	±10%, ±20%	0.85	±0.15	±0.15	10.0%	Paper, 4Kpcs
C2012X5R105□EPS		C2012X5R105□EP	1V, 1kHz	1.0	uF	±10%, ±20%	1.25	±0.15	±0.20	10.0%	Embossed, 3Kpcs	(I)
C2012X5R225□ETS		C2012X5R225□ET	1V, 1kHz	2.2	uF	±10%, ±20%	1.25	±0.15/±0.20	±0.20	10.0%		(II)
C2012X5R335□EPS		C2012X5R335□EP	1V, 1kHz	3.3	uF	±10%, ±20%	1.25	±0.20	±0.20	10.0%		(II)
C2012X5R475□ETS		C2012X5R475□ET	0.5V, 1kHz	4.7	uF	±10%, ±20%	0.85	±0.20	±0.10	10.0%	Paper, 4Kpcs	(II)
C2012X5R475□EPS		C2012X5R475□EP	1V, 1kHz	4.7	uF	±10%, ±20%	1.25	±0.15/±0.20	±0.20	10.0%	Embossed, 3Kpcs	(II)
C2012X5R106□ETS		C2012X5R106□ET	1V, 1kHz	10	uF	±10%, ±20%	0.85	±0.15	±0.10	10.0%	Paper, 4Kpcs	(II)*
C2012X5R106□EPS		C2012X5R106□EP	1V, 1kHz	10	uF	±10%, ±20%	1.25	±0.15/±0.20	±0.20	10.0%	Embossed, 3Kpcs	(II)*
C2012X5R226METS		C2012X5R226MET	0.5V, 120Hz	22	uF	±20%	0.85	±0.20	±0.10	10.0%	Paper, 4Kpcs	(II)*
C2012X5R226MEPS		C2012X5R226MEP	0.5V, 120Hz	22	uF	±10%, ±20%	1.25	±0.20	±0.20	15.0%	Embossed, 3Kpcs	(II)*
10V	C2012X5R105□DPS	C2012X5R105□DP	1V, 1kHz	1.0	uF	±10%, ±20%	1.25	±0.15/±0.20	±0.20	10.0%	Embossed, 3Kpcs	(II)
	C2012X5R225□DTS	C2012X5R225□DT	1V, 1kHz	2.2	uF	±10%, ±20%	0.85	±0.15	±0.10	10.0%	Paper, 4Kpcs	(II)
	C2012X5R225□DPS	C2012X5R225□DP	1V, 1kHz	2.2	uF	±10%, ±20%	1.25	±0.15/±0.20	±0.20	10.0%		(II)
	C2012X5R335□DPS	C2012X5R335□DP	1V, 1kHz	3.3	uF	±10%, ±20%	1.25	±0.20	±0.20	10.0%	Embossed, 3Kpcs	(II)
	C2012X5R475□DPS	C2012X5R475□DP	1V, 1kHz	4.7	uF	±10%, ±20%	1.25	±0.15/±0.20	±0.20	10.0%		(II)
	C2012X5R106□DTS	C2012X5R106□DT	0.5V, 1kHz	10	uF	±10%, ±20%	0.85	±0.20	±0.10	10.0%	Paper, 4Kpcs	(II)
	C2012X5R106□DPS	C2012X5R106□DP	1V, 1kHz	10	uF	±10%, ±20%	1.25	±0.15/±0.20	±0.20	10.0%	Embossed, 3Kpcs	(II)
	C2012X5R226MDTS	C2012X5R226MDT	0.5V, 120Hz	22	uF	±20%	0.85	±0.20	±0.10	10.0%	Paper, 4Kpcs	(II)*
	C2012X5R226MDPS	C2012X5R226MDP	0.5V, 120Hz	22	uF	±20%	1.25	±0.20	±0.20	15.0%		(II)*
	C2012X5R476MDPS	C2012X5R476MDP	0.5V, 120Hz	47	uF	±20%	1.25	±0.20	±0.20	10.0%	Embossed, 3Kpcs	(II)*
6.3V	C2012X5R225KCTS	C2012X5R225KCT	1V, 1kHz	2.2	uF	±10%	0.85	±0.15	±0.10	10.0%	Paper, 4Kpcs	(II)
	C2012X5R225□CPS	C2012X5R225□CP	1V, 1kHz	2.2	uF	±10%, ±20%	1.25	±0.15/±0.20	±0.20	10.0%		(II)
	C2012X5R335□CPS	C2012X5R335□CP	1V, 1kHz	3.3	uF	±10%, ±20%	1.25	±0.20	±0.20	10.0%	Embossed, 3Kpcs	(II)
	C2012X5R475□CPS	C2012X5R475□CP	1V, 1kHz	4.7	uF	±10%, ±20%	1.25	±0.15/±0.20	±0.20	10.0%		(I)
	C2012X5R106□CTS	C2012X5R106□CT	0.5V, 1kHz	10	uF	±10%, ±20%	0.85	±0.20	±0.15	10.0%	Paper, 4Kpcs	(II)
	C2012X5R106□CPS	C2012X5R106□CP	1V, 1kHz	10	uF	±10%, ±20%	1.25	±0.15/±0.20	±0.20	10.0%	Embossed, 3Kpcs	(II)
	C2012X5R226MCTS	C2012X5R226MCT	0.5V, 120Hz	22	uF	±20%	0.85	±0.15	±0.15	10.0%	Paper, 4Kpcs	(II)
	C2012X5R226□CPS	C2012X5R226□CP	0.5V, 120Hz	22	uF	±10%, ±20%	1.25	±0.15	±0.15	10.0%	Embossed, 3Kpcs	(II)
	C2012X5R476MCTS	C2012X5R476MCT	0.5V, 120Hz	47	uF	±20%	0.85	±0.20	±0.15	10.0%	Paper, 4Kpcs	(II)*
	C2012X5R476MCPS	C2012X5R476MCP	0.5V, 120Hz	47	uF	±20%	1.25	±0.20	±0.20	10.0%	Embossed, 3Kpcs	(II)*
4V	C2012X5R226MBPS	C2012X5R226MBP	0.5V, 120Hz	22	uF	±20%	1.25	±0.15	±0.15	10.0%		(II)
	C2012X5R476MBPS	C2012X5R476MBP	0.5V, 120Hz	47	uF	±20%	1.25	±0.20	±0.20	10.0%	Embossed, 3Kpcs	(II)*
	C2012X5R107MBPS	C2012X5R107MBP	0.5V, 120Hz	100	uF	±20%	1.25	±0.20	±0.20	15.0%		(II)*

□ Tolerance Code: K=±10%, M=±20% ;Special tolerance on the request.

(II)* High temperature load life test are applicable in rated voltage *100%. (II)/(II)* are applied with derating voltage.

● C3216X5R Series (EIA1206)

RV	DARFON P/N	DARFON P/N 2	Measuring Condition	Capacitance		Available Tolerance	Thick. (mm)	Tolerance(mm)		DF (max.)	Standard Packing	Test Spec.
				Value	Unit			L/W	Thick.			
50V	C3216X5R105KGPS	C3216X5R105KGP	1V, 1kHz	1.0	uF	±10%	1.60	±0.30	±0.30	3.5%	Embossed, 2Kpcs	(I)
	C3216X5R225□GTS	C3216X5R225□GT	1V, 1kHz	2.2	uF	±10%, ±20%	0.85	±0.15	±0.10	10.0%	Paper, 4Kpcs	(II)
	C3216X5R225KGPS	C3216X5R225KGP	1V, 1kHz	2.2	uF	±10%	1.60	±0.20	±0.20	10.0%	Embossed, 2Kpcs	(II)
	C3216X5R475□GTS	C3216X5R475□GT	1V, 1kHz	4.7	uF	±10%, ±20%	0.85	±0.15	±0.10	10.0%	Paper, 4Kpcs	(II)
	C3216X5R475□GPS	C3216X5R475□GP	1V, 1kHz	4.7	uF	±10%, ±20%	1.60	±0.20	±0.30	10.0%	Embossed, 2Kpcs	(II)
35V	C3216X5R106□GPS	C3216X5R106□GP	1V, 1kHz	10	uF	±10%, ±20%	1.60	±0.20	±0.20	10.0%	Embossed, 2Kpcs	(II)
	C3216X5R225□NPS	C3216X5R225□NP	1V, 1kHz	2.2	uF	±10%, ±20%	1.60	±0.20	±0.30	10.0%	Embossed, 2Kpcs	(II)
	C3216X5R106□NTS	C3216X5R106□NT	1V, 1kHz	10	uF	±10%, ±20%	0.85	±0.15	±0.10	10.0%	Paper, 4Kpcs	(II)*
25V	C3216X5R106□NPS	C3216X5R106□NP	1V, 1kHz	10	uF	±10%, ±20%	1.60	±0.20	±0.30	10.0%	Embossed, 2Kpcs	(II)
	C3216X5R105KF TSE		1V, 1kHz	1.0	uF	±10%	0.85	±0.15	±0.10	3.5%	Paper, 4Kpcs	(I)
	C3216X5R105KFPSL	C3216X5R105KFP	1V, 1kHz	1.0	uF	±10%	1.60	±0.30	±0.30	3.5%	Embossed, 2Kpcs	(I)
	C3216X5R225□FPS	C3216X5R225□FP	1V, 1kHz	2.2	uF	±10%, ±20%	1.60	±0.20	±0.30	5.0%	Embossed, 2Kpcs	(I)
	C3216X5R475□FPS	C3216X5R475□FP	1V, 1kHz	4.7	uF	±10%, ±20%	1.60	±0.20	±0.30	5.0%	Embossed, 2Kpcs	(II)
	C3216X5R106□FPS	C3216X5R106□FP	1V, 1kHz	10	uF	±10%, ±20%	1.60	±0.20	±0.30	10.0%	Embossed, 2Kpcs	(II)
	C3216X5R226□MFTSE	C3216X5R226MFT	0.5V, 120Hz	22	uF	±20%	0.85	±0.20	±0.20	10.0%	Paper, 4Kpcs	(II)*
	C3216X5R226□FPSL	C3216X5R226□FP	0.5V, 120Hz	22	uF	±10%, ±20%	1.60	±0.30	±0.30	10.0%	Embossed, 2Kpcs	(II)*
16V	C3216X5R476MFPSL	C3216X5R476MFP	0.5V, 120Hz	47	uF	±20%	1.60	±0.30	±0.30	15.0%	Embossed, 2Kpcs	(II)*
	C3216X5R225□EPS	C3216X5R225□EP	1V, 1kHz	2.2	uF	±10%, ±20%	1.60	±0.20	±0.30	5.0%	Embossed, 2Kpcs	(I)
	C3216X5R475□EPS	C3216X5R475□EP	1V, 1kHz	4.7	uF	±10%, ±20%	1.60	±0.20	±0.30	5.0%	Embossed, 2Kpcs	(II)
	C3216X5R106□EPS	C3216X5R106□EP	1V, 1kHz	10	uF	±10%, ±20%	1.60	±0.20	±0.30	10.0%	Embossed, 2Kpcs	(II)
	C3216X5R226□EPS	C3216X5R226□EP	0.5V, 120Hz	22	uF	±10%, ±20%	1.60	±0.20	±0.30	10.0%	Embossed, 2Kpcs	(II)
10V	C3216X5R476MEPS	C3216X5R476MEP	0.5V, 120Hz	47	uF	±20%	1.60	±0.30	±0.30	10.0%	Embossed, 2Kpcs	(II)
	C3216X5R225□DPS	C3216X5R225□DP	1V, 1kHz	2.2	uF	±10%, ±20%	1.60	±0.20	±0.30	7.5%	Embossed, 2Kpcs	(I)
	C3216X5R475□DPS	C3216X5R475□DP	1V, 1kHz	4.7	uF	±10%, ±20%	1.60	±0.20	±0.30	7.5%	Embossed, 2Kpcs	(II)
	C3216X5R106□DPS	C3216X5R106□DP	1V, 1kHz	10	uF	±10%, ±20%	1.60	±0.30	±0.30	10.0%	Embossed, 2Kpcs	(II)
	C3216X5R226□DPS	C3216X5R226□DP	0.5V, 120Hz	22	uF	±10%, ±20%	1.60	±0.30	±0.30	10.0%	Embossed, 2Kpcs	(II)
	C3216X5R476□DPS	C3216X5R476□DP	0.5V, 120Hz	47	uF	±10%, ±20%	1.60	±0.30/±0.20	±0.20	10.0%	Embossed, 2Kpcs	(II)
6.3V	C3216X5R107MDPS	C3216X5R107MDP	0.5V, 120Hz	100	uF	±20%	1.60	±0.30	±0.30	15.0%	Embossed, 2Kpcs	(II)*
	C3216X5R106KCPS	C3216X5R106KCP	1V, 1kHz	10	uF	±10%	1.60	±0.20	±0.30	15.0%	Embossed, 2Kpcs	(II)
	C3216X5R226□CPS	C3216X5R226□CP	0.5V, 120Hz	22	uF	±10%, ±20%	1.60	±0.20	±0.30	15.0%	Embossed, 2Kpcs	(II)
	C3216X5R476MCPS	C3216X5R476MCP	0.5V, 120Hz	47	uF	±20%	1.60	±0.20	±0.20	10.0%	Embossed, 2Kpcs	(II)
	C3216X5R107MCPS	C3216X5R107MCP	0.5V, 120Hz	100	uF	±20%	1.60	±0.30	±0.30	15.0%	Embossed, 2Kpcs	(II)
4V	C3216X5R226□BPS	C3216X5R226□BP	0.5V, 120Hz	22	uF	±10%, ±20%	1.60	±0.20	±0.30	15.0%	Embossed, 2Kpcs	(II)
	C3216X5R476MBPS	C3216X5R476MBP	0.5V, 120Hz	47	uF	±20%	1.60	±0.20	±0.30	15.0%	Embossed, 2Kpcs	(II)
	C3216X5R107MBPS	C3216X5R107MBP	0.5V, 120Hz	100	uF	±20%	1.60	±0.30	±0.30	15.0%	Embossed, 2Kpcs	(II)
	C3216X5R227MBPSL	C3216X5R227MBP	0.5V, 120Hz	220	uF	±20%	1.60	±0.30	±0.30	15.0%	Embossed, 2Kpcs	(II)

● C3225X5R Series (EIA1210)

RV	DARFON P/N	DARFON P/N 2	Measuring Condition	Capacitance		Available Tolerance	Thick. (mm)	Tolerance(mm)		DF (max.)	Standard Packing	Test Spec.
				Value	Unit			L/W	Thick.			
50V	C3225X5R106□GPS	C3225X5R106□GP	1V, 1kHz	10	uF	±10%, ±20%	2.50	±0.30/±0.20	±0.20	5.0%	Embossed, 1Kpcs	(II)
35V	C3225X5R106□NPS	C3225X5R106□NP	1V, 1kHz	10	uF	±10%, ±20%	2.50	±0.30/±0.20	±0.20	5.0%	Embossed, 1Kpcs	(I)
25V	C3225X5R475□FWS	C3225X5R475□FW	1V, 1kHz	4.7	uF	±10%, ±20%	2.00	±0.30/±0.20	±0.20	10.0%	Embossed, 1Kpcs	(I)
	C3225X5R106□FPS	C3225X5R106□FP	1V, 1kHz	10	uF	±10%, ±20%	2.00	±0.30/±0.20	±0.20	10.0%	Embossed, 2Kpcs	(I)
	C3225X5R226□FPS	C3225X5R226□FP	0.5V, 120Hz	22	uF	±10%, ±20%	2.50	±0.30/±0.20	±0.20	10.0%	Embossed, 1Kpcs	(II)
16V	C3225X5R475□EWS	C3225X5R475□EW	1V, 1kHz	4.7	uF	±10%, ±20%	2.00	±0.30/±0.20	±0.20	5.0%	Embossed, 1Kpcs	(I)
	C3225X5R106□EPS	C3225X5R106□EP	1V, 1kHz	10	uF	±10%, ±20%	2.00	±0.30/±0.20	±0.20	5.0%	Embossed, 2Kpcs	(I)
	C3225X5R226□EWS	C3225X5R226□EW	0.5V, 120Hz	22	uF	±10%, ±20%	2.50	±0.30/±0.20	±0.20	15.0%	Embossed, 0.5Kpcs	(II)
	C3225X5R226□EPS	C3225X5R226□EP	0.5V, 120Hz	22	uF	±10%, ±20%	2.50	±0.30/±0.20	±0.20	10.0%	Embossed, 1Kpcs	(II)
	C3225X5R476□EPS	C3225X5R476□EP	0.5V, 120Hz	47	uF	±10%, ±20%	2.50	±0.30/±0.20	±0.20	15.0%	Embossed, 1Kpcs	(II)
10V	C3225X5R107MEPS	C3225X5R107MEP	0.5V, 120Hz	100	uF	±20%	2.50	±0.30	±0.30	10.0%	Embossed, 1Kpcs	(II)
	C3225X5R106KDPS	C3225X5R106KDP	1V, 1kHz	10	uF	±10%	2.00	±0.30/±0.20	±0.20	5.0%	Embossed, 2Kpcs	(I)
	C3225X5R226□DPS	C3225X5R226□DP	0.5V, 120Hz	22	uF	±10%, ±20%	2.50	±0.30/±0.20	±0.20	10.0%	Embossed, 2Kpcs	(II)
	C3225X5R476□DPS	C3225X5R476□DP	0.5V, 120Hz	47	uF	±10%, ±20%	2.50	±0.30/±0.20	±0.20	10.0%	Embossed, 1Kpcs	(II)
	C3225X5R107MDPS	C3225X5R107MDP	0.5V, 120Hz	100	uF	±20%	2.50	±0.30/±0.20	±0.30	10.0%	Embossed, 1Kpcs	(II)
6.3V	C3225X5R226□CPS	C3225X5R226□CP	0.5V, 120Hz	22	uF	±10%, ±20%	2.50	±0.30/±0.20	±0.20	10.0%	Embossed, 1Kpcs	(II)
	C3225X5R476□CPS	C3225X5R476□CP	0.5V, 120Hz	47	uF	±10%, ±20%	2.50	±0.30/±0.20	±0.20	15.0%	Embossed, 1Kpcs	(II)
	C3225X5R107MCPS	C3225X5R107MCP	0.5V, 120Hz	100	uF	±20%	2.50	±0.30	±0.30	15.0%	Embossed, 1Kpcs	(II)
	C3225X5R227MCPS	C3225X5R227MCP	0.5V, 120Hz	220	uF	±20%	2.50	±0.30	±0.30	15.0%	Embossed, 1Kpcs	(II)*

● C4532X5R Series (EIA1812)

RV	DARFON P/N	DARFON P/N 2	Measuring Condition	Capacitance		Available Tolerance	Thick. (mm)	Tolerance(mm)		DF (max.)	Standard Packing	Test Spec.
				Value	Unit			L/W	Thick.			
50V	C4532X5R225KGPS	C4532X5R225KGP	1V, 1kHz	2.2	uF	±10%	1.60	±0.30	±0.20	10.0%	Embossed, 1Kpcs	(II)*

□ Tolerance Code: K=±10%, M=±20% ;Special tolerance on the request.;

(II)* High temperature load life test are applicable in rated voltage *100%. (II)/(II)* are applied with derating voltage.

■ X6S Series

● C0603X6S Series (EIA0201)

RV	DARFON P/N	DARFON P/N 2	Measuring Condition	Capacitance		Available Tolerance	Thick. (mm)	Tolerance(mm)		DF (max.)	Standard Packing	Test Spec.	
				Value	Unit			L/W	Thick.				
25V	C0603X6S103KFTS	C0603X6S103KFT	1V, 1kHz	10	nF	±10%	0.30	± 0.03	±0.03	5%	Paper, 15Kpcs	(I)	
	C0603X6S104□FTS	C0603X6S104□FT	1V, 1kHz	100	nF	±10%, ±20%	0.30	± 0.03	±0.03	10%		(II)*	
16V	C0603X6S103KETS	C0603X6S103KET	1V, 1kHz	10	nF	±10%	0.30	± 0.03	± 0.03	5%	Paper, 15Kpcs	(I)	
	C0603X6S104□ETS	C0603X6S104□ET	1V, 1kHz	100	nF	±10%, ±20%	0.30	± 0.05	±0.05	10%		(II)*	
10V	C0603X6S473□DTS	C0603X6S473□DT	1V, 1kHz	47	nF	±10%, ±20%	0.30	± 0.03	± 0.03	5%	Paper, 15Kpcs	(I)	
	C0603X6S104KDTS	C0603X6S104KDT	1V, 1kHz	100	nF	±10%	0.30	± 0.05	±0.05	10%		(II)	
	C0603X6S224□DTS	C0603X6S224□DT	1V, 1kHz	220	nF	±10%, ±20%	0.30	± 0.03	±0.03	10%		(II)*	
	C0603X6S105MDTS	C0603X6S105MDT	1V, 1kHz	1.0	uF	±20%	0.30	± 0.09	±0.09	10%		(II)*	
6.3V	C0603X6S103□CTS	C0603X6S103□CT	1V, 1kHz	10	nF	±10%, ±20%	0.30	± 0.03	±0.03	5%	Paper, 15Kpcs	(I)	
	C0603X6S153KCTS	C0603X6S153KCT	1V, 1kHz	15	nF	±10%	0.30	± 0.05	±0.05	10%		(II)	
	C0603X6S223KCTS	C0603X6S223KCT	1V, 1kHz	22	nF	±10%	0.30	± 0.05	±0.05	10%		(II)	
	C0603X6S333□CTS	C0603X6S333□CT	1V, 1kHz	33	nF	±10%, ±20%	0.30	± 0.05	±0.05	10%		(II)	
	C0603X6S473□CTS	C0603X6S473□CT	1V, 1kHz	47	nF	±10%, ±20%	0.30	± 0.05	±0.05	10%		(II)	
	C0603X6S104□CTS	C0603X6S104□CT	1V, 1kHz	100	nF	±10%, ±20%	0.30	± 0.05	±0.05	10%		(II)*	
	C0603X6S224□CTS	C0603X6S224□CT	0.5V, 1kHz	220	nF	±10%, ±20%	0.30	± 0.03	±0.03	10%		(II)*	
	C0603X6S474MCTS	C0603X6S474MCT	1V, 1kHz	470	nF	±20%	0.30	± 0.09	± 0.09	10%		(II)*	
	C0603X6S105MCTS	C0603X6S105MCT	0.5V, 1kHz	1.0	uF	±20%	0.30	± 0.09	± 0.09	10%		(II)*	
	C0603X6S225MCTSB	C0603X6S225MCT	0.5V, 1kHz	2.2	uF	±20%	0.50	±0.09	±0.05	15%		Paper, 10Kpcs	(II)*
	4V	C0603X6S104□BTS	C0603X6S104□BT	1V, 1kHz	100	nF	±10%, ±20%	0.30	± 0.05	±0.05		10%	Paper, 15Kpcs
C0603X6S224□BTS		C0603X6S224□BT	0.5V, 1kHz	220	nF	±10%, ±20%	0.30	± 0.03	±0.03	10%	(II)		
C0603X6S474MBTS		C0603X6S474MBT	1V, 1kHz	470	nF	±20%	0.30	± 0.05	±0.05	10%	(II)*		
C0603X6S105MBTS		C0603X6S105MBT	0.5V, 1kHz	1.0	uF	±20%	0.30	± 0.09	± 0.09	10%	(II)*		
C0603X6S225MBTS		C0603X6S225MBT	0.5V, 1kHz	2.2	uF	±20%	0.30	± 0.09	± 0.09	10%	(II)*		
2.5V	C0603X6S225MTTS	C0603X6S225MTT	0.5V, 1kHz	2.2	uF	±20%	0.30	± 0.09	± 0.09	10%	Paper, 15Kpcs	(II)*	

● C1005X6S Series (EIA0402)

RV	DARFON P/N	DARFON P/N 2	Measuring Condition	Capacitance		Available Tolerance	Thick. (mm)	Tolerance(mm)		DF (max.)	Standard Packing	Test Spec.
				Value	Unit			L/W	Thick.			
25V	C1005X6S104KFTS	C1005X6S104KFT	1V, 1kHz	100	nF	±10%	0.50	±0.05	±0.05	10.0%	Paper, 10Kpcs	(II)
	C1005X6S224KFTS	C1005X6S224KFT	1V, 1kHz	220	nF	±10%	0.50	±0.10	±0.10	10.0%		(II)
	C1005X6S105□FTS	C1005X6S105□FT	0.5V, 1kHz	1.0	uF	±10%, ±20%	0.50	±0.10	±0.10	10.0%		(II)*
	C1005X6S225□FTS	C1005X6S225□FT	1V, 1kHz	2.2	uF	±10%, ±20%	0.50	±0.20	±0.20	10.0%		(II)*
16V	C1005X6S153□ETS	C1005X6S153□ET	1V, 1kHz	15	nF	±5%, ±10%	0.50	±0.05	±0.05	3.0%	Paper, 10Kpcs	(I)
	C1005X6S104KETS	C1005X6S104KET	1V, 1kHz	100	nF	±10%	0.50	±0.05	±0.05	10.0%		(II)
	C1005X6S224KETS	C1005X6S224KET	1V, 1kHz	220	nF	±10%	0.50	±0.10	±0.10	10.0%		(II)
	C1005X6S334KETS	C1005X6S334KET	1V, 1kHz	330	nF	±10%	0.50	±0.10	±0.10	12.5%		(II)*
	C1005X6S474□ETS	C1005X6S474□ET	1V, 1kHz	470	nF	±10%, ±20%	0.50	±0.10	±0.10	12.5%		(II)*
	C1005X6S105□ETS	C1005X6S105□ET	1V, 1kHz	1.0	uF	±10%, ±20%	0.50	±0.10	±0.10	12.5%		(II)*
	C1005X6S225□ETS	C1005X6S225□ET	1V, 1kHz	2.2	uF	±10%, ±20%	0.50	±0.20	±0.20	10.0%		(II)
10V	C1005X6S105□DTS	C1005X6S105□DT	1V, 1kHz	1.0	uF	±10%, ±20%	0.50	±0.05	±0.05	12.5%	Paper, 10Kpcs	(II)*
	C1005X6S225□DTS	C1005X6S225□DT	1V, 1kHz	2.2	uF	±10%, ±20%	0.50	±0.20	±0.20	12.5%		(II)*
	C1005X6S475MDTS	C1005X6S475MDT	1V, 1kHz	4.7	uF	±20%	0.50	±0.20	±0.20	10.0%		(II)
6.3V	C1005X6S224KCTS	C1005X6S224KCT	1V, 1kHz	220	nF	±10%	0.50	±0.10	±0.10	10.0%	Paper, 10Kpcs	(II)
	C1005X6S334KCTS	C1005X6S334KCT	1V, 1kHz	330	nF	±10%	0.50	±0.10	±0.10	12.5%		(II)*
	C1005X6S684KCTS	C1005X6S684KCT	1V, 1kHz	680	nF	±10%	0.50	±0.10	±0.10	12.5%		(II)*
	C1005X6S105□CTS	C1005X6S105□CT	1V, 1kHz	1.0	uF	±10%, ±20%	0.50	±0.05	±0.05	12.5%		(II)*
	C1005X6S225□CTS	C1005X6S225□CT	0.5V, 1kHz	2.2	uF	±10%, ±20%	0.50	±0.15	±0.15	12.5%		(II)*
	C1005X6S475MCTS	C1005X6S475MCT	0.5V, 1kHz	4.7	uF	±20%	0.50	±0.15	±0.15	10.0%		(II)*
	C1005X6S106MCTS	C1005X6S106MCT	0.5V, 1kHz	10	uF	±20%	0.50	±0.20	±0.20	10.0%		(II)*
4V	C1005X6S334KBTS	C1005X6S334KBT	1V, 1kHz	330	nF	±10%	0.50	±0.10	±0.10	10.0%	Paper, 10Kpcs	(II)
	C1005X6S105□BTS	C1005X6S105□BT	1V, 1kHz	1.0	uF	±10%, ±20%	0.50	±0.05	±0.05	10.0%		(II)*
	C1005X6S155□BTS	C1005X6S155□BT	1V, 1kHz	1.5	uF	±10%, ±20%	0.50	±0.15	±0.15	12.5%		(II)*
	C1005X6S225□BTS	C1005X6S225□BT	0.5V, 1kHz	2.2	uF	±10%, ±20%	0.50	±0.15	±0.15	12.5%		(II)*
	C1005X6S475MBTS	C1005X6S475MBT	0.5V, 1kHz	4.7	uF	±20%	0.50	±0.15	±0.15	10.0%		(II)*
2.5V	C1005X6S106MBTS	C1005X6S106MBT	0.5V, 1kHz	10	uF	±20%	0.50	±0.20	±0.20	10.0%	Paper, 10Kpcs	(II)*
	C1005X6S106MTTS	C1005X6S106MTT	0.5V, 1kHz	10	uF	±20%	0.50	±0.20	±0.20	10.0%		(II)*
	C1005X6S226MTTS	C1005X6S226MTT	0.5V, 120Hz	22	uF	±20%	0.50	±0.30	±0.30	20.0%		(II)*

□ Tolerance Code: K=±10%, M=±20% ;Special tolerance on the request.

(II)* High temperature load life test are applicable in rated voltage *100%. (II)/(II)* are applied with derating voltage.

● C1608X6S Series (EIA0603)

RV	DARFON P/N	DARFON P/N 2	Measuring Condition	Capacitance		Available Tolerance	Thick. (mm)	Tolerance(mm)		DF (max.)	Standard Packing	Test Spec.
				Value	Unit			L/W	Thick.			
25V	C1608X6S105KFTS	C1608X6S105KFT	1V , 1kHz	1.0	uF	±10%	0.80	±0.15	±0.15	10.0%	Paper, 4Kpcs	(II)
	C1608X6S225KFTS	C1608X6S225KFT	1V , 1kHz	2.2	uF	±10%	0.80	±0.20	±0.20	10.0%		(II)*
	C1608X6S475□FTS	C1608X6S475□FT	1V , 1kHz	4.7	uF	±10%,±20%	0.80	±0.20	±0.20	10.0%		(II)*
16V	C1608X6S105KETS	C1608X6S105KET	1V , 1kHz	1.0	uF	±10%	0.80	±0.15	±0.15	10.0%	Paper, 4Kpcs	(II)
	C1608X6S225□ETS	C1608X6S225□ET	1V , 1kHz	2.2	uF	±10%,±20%	0.80	±0.10	±0.10	10.0%		(II)*
	C1608X6S475□ETS	C1608X6S475□ET	1V , 1kHz	4.7	uF	±10%,±20%	0.80	±0.20	±0.20	10.0%		(II)*
	C1608X6S106METS	C1608X6S106MET	1V , 1kHz	10	uF	±20%	0.80	±0.20	±0.20	10.0%		(II)
10V	C1608X6S225KDTS	C1608X6S225KDT	1V , 1kHz	2.2	uF	±10%	0.80	±0.10	±0.10	10.0%	Paper, 4Kpcs	(II)
	C1608X6S475□DTS	C1608X6S475□DT	1V , 1kHz	4.7	uF	±10%,±20%	0.80	±0.15	±0.15	10.0%		(II)
	C1608X6S106MDTS	C1608X6S106MDT	1V , 1kHz	10	uF	±20%	0.80	±0.20	±0.20	10.0%		(II)
6.3V	C1608X6S225□CTS	C1608X6S225□CT	1V , 1kHz	2.2	uF	±10%,±20%	0.80	±0.10	±0.10	10.0%	Paper, 4Kpcs	(II)*
	C1608X6S475□CTS	C1608X6S475□CT	1V , 1kHz	4.7	uF	±10%,±20%	0.80	±0.10	±0.10	10.0%		(II)*
	C1608X6S106□CTS	C1608X6S106□CT	1V , 1kHz	10	uF	±10%,±20%	0.80	±0.20	±0.20	10.0%		(II)*
	C1608X6S226MCTS	C1608X6S226MCT	0.5V , 120Hz	22	uF	±20%	0.80	±0.20	±0.20	10.0%		(II)*
4V	C1608X6S475□BTS	C1608X6S475□BT	1V , 1kHz	4.7	uF	±10%,±20%	0.80	±0.10	±0.10	10.0%	Paper, 4Kpcs	(II)*
	C1608X6S106MBTS	C1608X6S106MBT	1V , 1kHz	10	uF	±20%	0.80	±0.20	±0.20	10.0%		(II)*
	C1608X6S226MBTS	C1608X6S226MBT	0.5V , 120Hz	22	uF	±20%	0.80	±0.20	±0.20	10.0%		(II)*
	C1608X6S476MBTS	C1608X6S476MBT	0.5V , 120Hz	47	uF	±20%	0.80	±0.20	±0.20	15.0%		(II)*
2.5V	C1608X6S476MTTS	C1608X6S476MTT	0.5V , 120Hz	47	uF	±20%	0.80	±0.20	±0.20	15.0%	Paper, 4Kpcs	(II)*

● C2012X6S Series (EIA0805)

RV	DARFON P/N	DARFON P/N 2	Measuring Condition	Capacitance		Available Tolerance	Thick. (mm)	Tolerance(mm)		DF (max.)	Standard Packing	Test Spec.
				Value	Unit			L/W	Thick.			
50V	C2012X6S104KGTS	C2012X6S104KGT	1V , 1kHz	100	nF	±10%	0.80	±0.15	±0.10	2.5%	Paper, 4Kpcs	(I)
	C2012X6S475KGPS	C2012X6S475KGP	1V , 1kHz	4.7	uF	±10%	1.25	±0.20	±0.20	10.0%	Embossed, 3Kpcs	(II)
35V	C2012X6S106KNPS	C2012X6S106KNP	1V , 1kHz	10.0	uF	±10%	1.25	±0.20	±0.20	10.0%	Embossed, 3Kpcs	(II)
25V	C2012X6S225KFPS	C2012X6S225KFP	1V , 1kHz	2.2	uF	±10%	1.25	±0.15/±0.20	±0.20	10.0%	Embossed, 3Kpcs	(II)*
	C2012X6S475KFPS	C2012X6S475KFP	1V , 1kHz	4.7	uF	±10%	1.25	±0.15/±0.20	±0.20	12.5%		(II)*
	C2012X6S106□FPS	C2012X6S106□FP	1V , 1kHz	10	uF	±10%,±20%	1.25	±0.15/±0.20	±0.20	12.5%		(II)*
16V	C2012X6S106KEPS	C2012X6S106KEP	1V , 1kHz	10	uF	±10%	1.25	±0.15/±0.20	±0.20	10.0%	Embossed, 3Kpcs	(II)
	C2012X6S226MEPS	C2012X6S226MEP	0.5V , 120Hz	22	uF	±20%	1.25	±0.20	±0.20	10.0%		(II)*
10V	C2012X6S106KDPS	C2012X6S106KDP	1V , 1kHz	10	uF	±10%	1.25	±0.15/±0.20	±0.20	10.0%	Embossed, 3Kpcs	(II)*
	C2012X6S226MDPS	C2012X6S226MDP	0.5V , 120Hz	22	uF	±20%	1.25	±0.20	±0.20	10.0%		(II)
6.3V	C2012X6S106□CPS	C2012X6S106□CP	1V , 1kHz	10	uF	±10%,±20%	1.25	±0.15/±0.20	±0.20	10.0%	Embossed, 3Kpcs	(II)*
	C2012X6S226MCPS	C2012X6S226MCP	0.5V , 120Hz	22	uF	±20%	1.25	±0.20	±0.20	10.0%		(II)*
	C2012X6S476MCPS	C2012X6S476MCP	0.5V , 120Hz	47	uF	±20%	1.25	±0.20	±0.20	10.0%		(II)*
4V	C2012X6S106□BPS	C2012X6S106□BP	1V , 1kHz	10	uF	±10%,±20%	1.25	±0.15/±0.20	±0.20	10.0%	Embossed, 3Kpcs	(II)
	C2012X6S226MBPS	C2012X6S226MBP	0.5V , 120Hz	22	uF	±20%	1.25	±0.20	±0.20	10.0%		(II)
	C2012X6S476MBPS	C2012X6S476MBP	0.5V , 120Hz	47	uF	±20%	1.25	±0.20	±0.20	10.0%		(II)*
	C2012X6S107MBPS	C2012X6S107MBP	0.5V , 120Hz	100	uF	±20%	1.25	±0.20	±0.20	15.0%		(II)*
2.5V	C2012X6S107MTPS	C2012X6S107MTP	0.5V , 120Hz	100	uF	±20%	1.25	±0.20	±0.20	15.0%	Embossed, 3Kpcs	(II)*

□ Tolerance Code: K=±10%, M=±20% ;Special tolerance on the request.;

(II)* High temperature load life test are applicable in rated voltage *100%. (II)/(II)* are applied with derating voltage.

● C3216X6S Series (EIA1206)

RV	DARFON P/N	DARFON P/N 2	Measuring Condition	Capacitance		Available Tolerance	Thick. (mm)	Tolerance(mm)		DF (max.)	Standard Packing	Test Spec.
				Value	Unit			L/W	Thick.			
35V	C3216X6S106KNPS	C3216X6S106KNP	1V , 1kHz	10	uF	±10%	1.60	±0.30	±0.30	10.0%	Embossed, 2Kpcs	(II)*
	C3216X6S106KFPS	C3216X6S106KFP	1V , 1kHz	10	uF	±10%	1.60	±0.20	±0.20	10.0%	Embossed, 2Kpcs	(II)
25V	C3216X6S226□FPS	C3216X6S226□FP	0.5V , 120Hz	22	uF	±10%, ±20%	1.60	±0.30	±0.30	10.0%	Embossed, 2Kpcs	(II)
16V	C3216X6S226□EPS	C3216X6S226□EP	0.5V , 120Hz	22	uF	±10%, ±20%	1.60	±0.30	±0.30	10.0%	Embossed, 2Kpcs	(II)*
10V	C3216X6S226MDPS	C3216X6S226MDP	0.5V , 120Hz	22	uF	±20%	1.60	±0.30	±0.30	10.0%	Embossed, 2Kpcs	(II)
	C3216X6S476MDPS	C3216X6S476MDP	0.5V , 120Hz	47	uF	±20%	1.60	±0.30	±0.30	10.0%	Embossed, 2Kpcs	(II)
6.3V	C3216X6S476MCPS	C3216X6S476MCP	0.5V , 120Hz	47	uF	±20%	1.60	±0.30	±0.30	10.0%	Embossed, 2Kpcs	(II)
4V	C3216X6S226MBTS	C3216X6S226MBT	0.5V , 120Hz	22	uF	±20%	0.85	±0.20	±0.10	10.0%	Paper, 4Kpcs	(II)
	C3216X6S476MBPS	C3216X6S476MBP	0.5V , 120Hz	47	uF	±20%	1.60	±0.30	±0.30	10.0%		(II)
	C3216X6S107MBPS	C3216X6S107MBP	0.5V , 120Hz	100	uF	±20%	1.60	±0.20	±0.20	10.0%	Embossed, 2Kpcs	(II)
	C3216X6S227MBPS	C3216X6S227MBP	0.5V , 120Hz	220	uF	±20%	1.60	±0.30	±0.30	10.0%	Embossed, 2Kpcs	(II)*

● C3225X6S Series (EIA1210)

RV	DARFON P/N	DARFON P/N 2	Measuring Condition	Capacitance		Available Tolerance	Thick. (mm)	Tolerance(mm)		DF (max.)	Standard Packing	Test Spec.
				Value	Unit			L/W	Thick.			
25V	C3225X6S106KFPS	C3225X6S106KFP	1V , 1kHz	10	uF	±10%	2.00	±0.3/±0.2	±0.30	10.0%	Embossed, 2Kpcs	(II)
	C3225X6S226KFPS	C3225X6S226KFP	0.5V , 120Hz	22	uF	±10%	2.50	±0.30	±0.20	10.0%	Embossed, 1Kpcs	(II)
16V	C3225X6S476MEPS	C3225X6S476MEP	0.5V , 120Hz	47	uF	±20%	2.50	±0.30	±0.20	10.0%	Embossed, 1Kpcs	(II)*
6.3V	C3225X6S107MCPS	C3225X6S107MCP	0.5V , 120Hz	100	uF	±20%	2.50	±0.30	±0.30	10.0%	Embossed, 1Kpcs	(II)
2.5V	C3225X6S337MTPS	C3225X6S337MTP	0.5V , 120Hz	330	uF	±20%	2.50	±0.30	±0.30	10.0%	Embossed, 1Kpcs	(II)

□ Tolerance Code: K=±10%, M=±20% ;Special tolerance on the request.;

(II)* High temperature load life test are applicable in rated voltage *100%. (II)/(II)* are applied with derating voltage.

- X6T Series
- C1005X6T Series (EIA0402)

RV	DARFON P/N	DARFON P/N 2	Measuring Condition	Capacitance		Available Tolerance	Thick. (mm)	Tolerance(mm)		DF (max.)	Standard Packing	Test Spec.
				Value	Unit			L/W	Thick.			
25V	C1005X6T105KFTS	C1005X6T105KFT	1V , 1kHz	1.0	uF	±10%	0.50	±0.10	±0.10	10.0%	Paper, 10Kpcs	(II)*
10V	C1005X6T475MDTS	C1005X6T475MDT	1V , 1kHz	4.7	uF	±20%	0.50	±0.20	±0.20	10.0%	Paper, 10Kpcs	(II)*
6.3V	C1005X6T475MCTS	C1005X6T475MCT	0.5V , 1kHz	4.7	uF	±20%	0.50	±0.15	±0.15	10.0%	Paper, 10Kpcs	(II)*

- C3216X6T Series (EIA1206)

RV	DARFON P/N	DARFON P/N 2	Measuring Condition	Capacitance		Available Tolerance	Thick. (mm)	Tolerance(mm)		DF (max.)	Standard Packing	Test Spec.
				Value	Unit			L/W	Thick.			
6.3V	C3216X6T107MCPS	C3216X6T107MCP	0.5V , 120Hz	100	uF	±20%	1.60	±0.30	±0.30	15.0%	Embossed, 2Kpcs	(II)*

□ Tolerance Code: K=±10%, M=±20% ;Special tolerance on the request.;

(II)* High temperature load life test are applicable in rated voltage *100%. (II)/(II)* are applied with derating voltage.

■ X7R Series
● C0603X7R Series(EIA0201)

RV	DARFON P/N	DARFON P/N 2	Measuring Condition	Capacitance		Available Tolerance	Thick. (mm)	Tolerance(mm)		DF (max.)	Standard Packing	Test Spec.
				Value	Unit			L/W	Thick.			
50V	C0603X7R101□GTS	C0603X7R101□GT	1V, 1kHz	100	pF	±5%, ±10%	0.30	± 0.03	± 0.03	3.0%	Paper, 15Kpcs	(I)
	C0603X7R121KGTS	C0603X7R121KGT	1V, 1kHz	120	pF	±10%	0.30	± 0.03	± 0.03	3.0%		(I)
	C0603X7R151□GTS	C0603X7R151□GT	1V, 1kHz	150	pF	±5%, ±10%	0.30	± 0.03	± 0.03	3.0%		(I)
	C0603X7R181KGTS	C0603X7R181KGT	1V, 1kHz	180	pF	±10%	0.30	± 0.03	± 0.03	3.0%		(I)
	C0603X7R221□GTS	C0603X7R221□GT	1V, 1kHz	220	pF	±5%, ±10%	0.30	± 0.03	± 0.03	3.0%		(I)
	C0603X7R271KGTS	C0603X7R271KGT	1V, 1kHz	270	pF	±10%	0.30	± 0.03	± 0.03	3.0%		(I)
	C0603X7R331KGTS	C0603X7R331KGT	1V, 1kHz	330	pF	±10%	0.30	± 0.03	± 0.03	3.0%		(I)
	C0603X7R391KGTS	C0603X7R391KGT	1V, 1kHz	390	pF	±10%	0.30	± 0.03	± 0.03	3.0%		(I)
	C0603X7R471KGTS	C0603X7R471KGT	1V, 1kHz	470	pF	±10%	0.30	± 0.03	± 0.03	3.0%		(I)
	C0603X7R561KGTS	C0603X7R561KGT	1V, 1kHz	560	pF	±10%	0.30	± 0.03	± 0.03	3.0%		(I)
	C0603X7R681□GTS	C0603X7R681□GT	1V, 1kHz	680	pF	±5%, ±10%	0.30	± 0.03	± 0.03	3.0%		(I)
	C0603X7R821KGTS	C0603X7R821KGT	1V, 1kHz	820	pF	±10%	0.30	± 0.03	± 0.03	3.0%		(I)
	C0603X7R102KGTS	C0603X7R102KGT	1V, 1kHz	1.0	nF	±10%	0.30	± 0.03	± 0.03	3.0%		(I)
	C0603X7R122KGTS	C0603X7R122KGT	1V, 1kHz	1.2	nF	±10%	0.30	± 0.03	± 0.03	3.0%		(I)
	C0603X7R152KGTS	C0603X7R152KGT	1V, 1kHz	1.5	nF	±10%	0.30	± 0.03	± 0.03	3.0%		(I)
	C0603X7R182KGTS	C0603X7R182KGT	1V, 1kHz	1.8	nF	±10%	0.30	± 0.03	± 0.03	3.0%		(I)
	C0603X7R222KGTS	C0603X7R222KGT	1V, 1kHz	2.2	nF	±10%	0.30	± 0.03	± 0.03	3.0%		(I)
	C0603X7R332KGTS	C0603X7R332KGT	1V, 1kHz	3.3	nF	±10%	0.30	± 0.03	± 0.03	5.0%		(I)
C0603X7R472KGTS	C0603X7R472KGT	1V, 1kHz	4.7	nF	±10%	0.30	± 0.03	± 0.03	5.0%	(I)		
C0603X7R682KGTS	C0603X7R682KGT	1V, 1kHz	6.8	nF	±10%	0.30	± 0.03	± 0.03	5.0%	(II)*		
C0603X7R103KGTS	C0603X7R103KGT	1V, 1kHz	10	nF	±10%	0.30	± 0.03	± 0.03	5.0%	(II)*		
25V	C0603X7R101KFTS	C0603X7R101KFT	1V, 1kHz	100	pF	±10%	0.30	± 0.03	± 0.03	3.5%	Paper, 15Kpcs	(I)
	C0603X7R121KFTS	C0603X7R121KFT	1V, 1kHz	120	pF	±10%	0.30	± 0.03	± 0.03	3.5%		(I)
	C0603X7R151KFTS	C0603X7R151KFT	1V, 1kHz	150	pF	±10%	0.30	± 0.03	± 0.03	3.5%		(I)
	C0603X7R181KFTS	C0603X7R181KFT	1V, 1kHz	180	pF	±10%	0.30	± 0.03	± 0.03	3.5%		(I)
	C0603X7R221□FTS	C0603X7R221□FT	1V, 1kHz	220	pF	±5%, ±10%	0.30	± 0.03	± 0.03	3.5%		(I)
	C0603X7R271KFTS	C0603X7R271KFT	1V, 1kHz	270	pF	±10%	0.30	± 0.03	± 0.03	3.5%		(I)
	C0603X7R331KFTS	C0603X7R331KFT	1V, 1kHz	330	pF	±10%	0.30	± 0.03	± 0.03	3.5%		(I)
	C0603X7R391KFTS	C0603X7R391KFT	1V, 1kHz	390	pF	±10%	0.30	± 0.03	± 0.03	3.5%		(I)
	C0603X7R471□FTS	C0603X7R471□FT	1V, 1kHz	470	pF	±5%, ±10%	0.30	± 0.03	± 0.03	3.5%		(I)
	C0603X7R561KFTS	C0603X7R561KFT	1V, 1kHz	560	pF	±10%	0.30	± 0.03	± 0.03	3.5%		(I)
	C0603X7R681KFTS	C0603X7R681KFT	1V, 1kHz	680	pF	±10%	0.30	± 0.03	± 0.03	3.5%		(I)
	C0603X7R821□FTS	C0603X7R821□FT	1V, 1kHz	820	pF	±5%, ±10%	0.30	± 0.03	± 0.03	3.5%		(I)
	C0603X7R102□FTS	C0603X7R102□FT	1V, 1kHz	1.0	nF	±5%, ±10%	0.30	± 0.03	± 0.03	3.5%		(I)
	C0603X7R122KFTS	C0603X7R122KFT	1V, 1kHz	1.2	nF	±10%	0.30	± 0.03	± 0.03	3.5%		(I)
	C0603X7R152KFTS	C0603X7R152KFT	1V, 1kHz	1.5	nF	±10%	0.30	± 0.03	± 0.03	3.5%		(I)
	C0603X7R182KFTS	C0603X7R182KFT	1V, 1kHz	1.8	nF	±10%	0.30	± 0.03	± 0.03	3.5%		(I)
	C0603X7R222KFTS	C0603X7R222KFT	1V, 1kHz	2.2	nF	±10%	0.30	± 0.03	± 0.03	3.5%		(I)
	C0603X7R332KFTS	C0603X7R332KFT	1V, 1kHz	3.3	nF	±10%	0.30	± 0.03	± 0.03	5.0%		(I)
C0603X7R472KFTS	C0603X7R472KFT	1V, 1kHz	4.7	nF	±10%	0.30	± 0.03	± 0.03	5.0%	(I)		
C0603X7R682KFTS	C0603X7R682KFT	1V, 1kHz	6.8	nF	±10%	0.30	± 0.03	± 0.03	5.0%	(I)		
C0603X7R103□FTS	C0603X7R103□FT	1V, 1kHz	10	nF	±10%, ±20%	0.30	± 0.03	± 0.03	5.0%	(I)		
16V	C0603X7R101KETS	C0603X7R101KET	1V, 1kHz	100	pF	±10%	0.30	± 0.03	± 0.03	3.5%	Paper, 15Kpcs	(I)
	C0603X7R121KETS	C0603X7R121KET	1V, 1kHz	120	pF	±10%	0.30	± 0.03	± 0.03	3.5%		(I)
	C0603X7R151KETS	C0603X7R151KET	1V, 1kHz	150	pF	±10%	0.30	± 0.03	± 0.03	3.5%		(I)
	C0603X7R181KETS	C0603X7R181KET	1V, 1kHz	180	pF	±10%	0.30	± 0.03	± 0.03	3.5%		(I)
	C0603X7R201□ETS	C0603X7R201□ET	1V, 1kHz	200	pF	±5%, ±10%	0.30	± 0.03	± 0.03	3.5%		(I)
	C0603X7R221KETS	C0603X7R221KET	1V, 1kHz	220	pF	±10%	0.30	± 0.03	± 0.03	3.5%		(I)
	C0603X7R271KETS	C0603X7R271KET	1V, 1kHz	270	pF	±10%	0.30	± 0.03	± 0.03	3.5%		(I)
	C0603X7R331□ETS	C0603X7R331□ET	1V, 1kHz	330	pF	±5%, ±10%	0.30	± 0.03	± 0.03	3.5%		(I)
	C0603X7R471KETS	C0603X7R471KET	1V, 1kHz	470	pF	±10%	0.30	± 0.03	± 0.03	3.5%		(I)
	C0603X7R561KETS	C0603X7R561KET	1V, 1kHz	560	pF	±10%	0.30	± 0.03	± 0.03	3.5%		(I)
	C0603X7R681□ETS	C0603X7R681□ET	1V, 1kHz	680	pF	±5%, ±10%	0.30	± 0.03	± 0.03	3.5%		(I)
	C0603X7R821□ETS	C0603X7R821□ET	1V, 1kHz	820	pF	±5%, ±10%	0.30	± 0.03	± 0.03	3.5%		(I)
	C0603X7R102□ETS	C0603X7R102□ET	1V, 1kHz	1.0	nF	±5%, ±10%	0.30	± 0.03	± 0.03	3.5%		(I)
	C0603X7R152□ETS	C0603X7R152□ET	1V, 1kHz	1.5	nF	±5%, ±10%	0.30	± 0.03	± 0.03	3.5%		(I)
	C0603X7R182KETS	C0603X7R182KET	1V, 1kHz	1.8	nF	±10%	0.30	± 0.03	± 0.03	3.5%		(I)
	C0603X7R222KETS	C0603X7R222KET	1V, 1kHz	2.2	nF	±10%	0.30	± 0.03	± 0.03	3.5%		(I)
	C0603X7R272□ETS	C0603X7R272□ET	1V, 1kHz	2.7	nF	±5%, ±10%	0.30	± 0.03	± 0.03	5.0%		(I)
	C0603X7R332KETS	C0603X7R332KET	1V, 1kHz	3.3	nF	±10%	0.30	± 0.03	± 0.03	5.0%		(I)
	C0603X7R392KETS	C0603X7R392KET	1V, 1kHz	3.9	nF	±10%	0.30	± 0.03	± 0.03	5.0%		(I)
	C0603X7R472KETS	C0603X7R472KET	1V, 1kHz	4.7	nF	±10%	0.30	± 0.03	± 0.03	5.0%		(I)
	C0603X7R562KETS	C0603X7R562KET	1V, 1kHz	5.6	nF	±10%	0.30	± 0.03	± 0.03	5.0%		(I)
	C0603X7R682KETS	C0603X7R682KET	1V, 1kHz	6.8	nF	±10%	0.30	± 0.03	± 0.03	5.0%		(I)
	C0603X7R822KETS	C0603X7R822KET	1V, 1kHz	8.2	nF	±10%	0.30	± 0.03	± 0.03	5.0%		(I)
	C0603X7R103□ETS	C0603X7R103□ET	1V, 1kHz	10	nF	±5%, ±10%	0.30	± 0.03	± 0.03	5.0%		(I)
C0603X7R153KETS	C0603X7R153KET	1V, 1kHz	15	nF	±10%	0.30	± 0.03	± 0.03	5.0%	(I)		
C0603X7R223KETS	C0603X7R223KET	1V, 1kHz	22	nF	±10%	0.30	± 0.03	± 0.03	5.0%	(I)		
C0603X7R333KETS	C0603X7R333KET	1V, 1kHz	33	nF	±10%	0.30	± 0.03	± 0.03	5.0%	(I)		
C0603X7R473KETS	C0603X7R473KET	1V, 1kHz	47	nF	±10%	0.30	± 0.03	± 0.03	5.0%	(I)		
C0603X7R104□ETS	C0603X7R104□ET	1V, 1kHz	100	nF	±10%, ±20%	0.30	± 0.05	± 0.05	10%	(II)*		

RV	DARFON P/N	DARFON P/N 2	Measuring Condition	Capacitance		Available Tolerance	Thick. (mm)	Tolerance(mm)		DF (max.)	Standard Packing	Test Spec.
				Value	Unit			L/W	Thick.			
10V	C0603X7R221□DTS	C0603X7R221□DT	1V , 1kHz	220	pF	±5%, ±10%	0.30	± 0.03	± 0.03	5.0%	Paper, 15Kpcs	(I)
	C0603X7R102KDTS	C0603X7R102KDT	1V , 1kHz	1.0	nF	±10%	0.30	± 0.03	± 0.03	5.0%		(I)
	C0603X7R182KDTS	C0603X7R182KDT	1V , 1kHz	1.8	nF	±10%	0.30	± 0.03	± 0.03	5.0%		(I)
	C0603X7R222KDTS	C0603X7R222KDT	1V , 1kHz	2.2	nF	±10%	0.30	± 0.03	± 0.03	5.0%		(I)
	C0603X7R272□DTS	C0603X7R272□DT	1V , 1kHz	2.7	nF	±5%, ±10%	0.30	± 0.03	± 0.03	5.0%		(I)
	C0603X7R332KDTS	C0603X7R332KDT	1V , 1kHz	3.3	nF	±10%	0.30	± 0.03	± 0.03	5.0%		(I)
	C0603X7R392KDTS	C0603X7R392KDT	1V , 1kHz	3.9	nF	±10%	0.30	± 0.03	± 0.03	5.0%		(I)
	C0603X7R472KDTS	C0603X7R472KDT	1V , 1kHz	4.7	nF	±10%	0.30	± 0.03	± 0.03	5.0%		(I)
	C0603X7R562KDTS	C0603X7R562KDT	1V , 1kHz	5.6	nF	±10%	0.30	± 0.03	± 0.03	5.0%		(I)
	C0603X7R682KDTS	C0603X7R682KDT	1V , 1kHz	6.8	nF	±10%	0.30	± 0.03	± 0.03	5.0%		(I)
	C0603X7R822KDTS	C0603X7R822KDT	1V , 1kHz	8.2	nF	±10%	0.30	± 0.03	± 0.03	5.0%		(I)
	C0603X7R103□DTS	C0603X7R103□DT	1V , 1kHz	10	nF	±5%, ±10%	0.30	± 0.03	± 0.03	5.0%		(I)
	C0603X7R473KDTS	C0603X7R473KDT	1V , 1kHz	47	nF	±10%	0.30	± 0.03	± 0.03	5.0%		(I)
C0603X7R104□DTS	C0603X7R104□DT	1V , 1kHz	100	nF	±10%, ±20%	0.30	± 0.05	± 0.05	10%	(II)		
6.3V	C0603X7R222KCTS	C0603X7R222KCT	1V , 1kHz	2.2	nF	±10%	0.30	± 0.03	± 0.03	5.0%	Paper, 15Kpcs	(I)
	C0603X7R332KCTS	C0603X7R332KCT	1V , 1kHz	3.3	nF	±10%	0.30	± 0.03	± 0.03	5.0%		(I)
	C0603X7R103KCTS	C0603X7R103KCT	1V , 1kHz	10	nF	±10%	0.30	± 0.03	± 0.03	5.0%		(I)
	C0603X7R153KCTS	C0603X7R153KCT	1V , 1kHz	15	nF	±10%	0.30	± 0.05	± 0.05	10%		(II)
	C0603X7R333KCTS	C0603X7R333KCT	1V , 1kHz	33	nF	±10%	0.30	± 0.05	± 0.05	10%		(II)
	C0603X7R104KCTS	C0603X7R104KCT	1V , 1kHz	100	nF	±10%	0.30	± 0.05	± 0.05	10%		(II)
	C0603X7R224KCTS	C0603X7R224KCT	1V , 1kHz	220	nF	±10%	0.30	± 0.05	± 0.05	12.5%		(II)*

□ Tolerance Code: K=±10%, M=±20% ;Special tolerance on the request.

(II)* High temperature load life test are applicable in rated voltage *100%. (II)/(II)* are applied with derating voltage.

● C1005X7R Series (EIA0402)

RV	DARFON P/N	DARFON P/N 2	Measuring Condition	Capacitance		Available Tolerance	Thick. (mm)	Tolerance(mm)		DF (max.)	Standard Packing	Test Spec.
				Value	Unit			L/W	Thick.			
50V	C1005X7R101□GTS	C1005X7R101□GT	1V, 1kHz	100	pF	±5%, ±10%	0.50	±0.05	±0.05	3.0%	Paper, 10Kpcs	(I)
	C1005X7R121KGTS	C1005X7R121KGT	1V, 1kHz	120	pF	±10%	0.50	±0.05	±0.05	3.0%		(I)
	C1005X7R151KGTS	C1005X7R151KGT	1V, 1kHz	150	pF	±10%	0.50	±0.05	±0.05	3.0%		(I)
	C1005X7R181KGTS	C1005X7R181KGT	1V, 1kHz	180	pF	±10%	0.50	±0.05	±0.05	3.0%		(I)
	C1005X7R201KGTS	C1005X7R201KGT	1V, 1kHz	200	pF	±10%	0.50	±0.05	±0.05	3.0%		(I)
	C1005X7R221KGTS	C1005X7R221KGT	1V, 1kHz	220	pF	±10%	0.50	±0.05	±0.05	3.0%		(I)
	C1005X7R271□GTS	C1005X7R271□GT	1V, 1kHz	270	pF	±5%, ±10%	0.50	±0.05	±0.05	3.0%		(I)
	C1005X7R301KGTS	C1005X7R301KGT	1V, 1kHz	300	pF	±10%	0.50	±0.05	±0.05	3.0%		(I)
	C1005X7R331□GTS	C1005X7R331□GT	1V, 1kHz	330	pF	±5%, ±10%	0.50	±0.05	±0.05	3.0%		(I)
	C1005X7R391□GTS	C1005X7R391□GT	1V, 1kHz	390	pF	±5%, ±10%	0.50	±0.05	±0.05	3.0%		(I)
	C1005X7R471□GTS	C1005X7R471□GT	1V, 1kHz	470	pF	±5%, ±10%	0.50	±0.05	±0.05	3.0%		(I)
	C1005X7R561KGTS	C1005X7R561KGT	1V, 1kHz	560	pF	±10%	0.50	±0.05	±0.05	3.0%		(I)
	C1005X7R681□GTS	C1005X7R681□GT	1V, 1kHz	680	pF	±5%, ±10%	0.50	±0.05	±0.05	3.0%		(I)
	C1005X7R751KGTS	C1005X7R751KGT	1V, 1kHz	750	pF	±10%	0.50	±0.05	±0.05	3.0%		(I)
	C1005X7R821KGTS	C1005X7R821KGT	1V, 1kHz	820	pF	±10%	0.50	±0.05	±0.05	3.0%		(I)
	C1005X7R102□GTS	C1005X7R102□GT	1V, 1kHz	1.0	nF	±5%, ±10%, ±20%	0.50	±0.05	±0.05	3.0%		(I)
	C1005X7R122□GTS	C1005X7R122□GT	1V, 1kHz	1.2	nF	±5%, ±10%	0.50	±0.05	±0.05	3.0%		(I)
	C1005X7R152KGTS	C1005X7R152KGT	1V, 1kHz	1.5	nF	±10%	0.50	±0.05	±0.05	3.0%		(I)
	C1005X7R182□GTS	C1005X7R182□GT	1V, 1kHz	1.8	nF	±5%, ±10%	0.50	±0.05	±0.05	3.0%		(I)
	C1005X7R222□GTS	C1005X7R222□GT	1V, 1kHz	2.2	nF	±5%, ±10%	0.50	±0.05	±0.05	3.0%		(I)
	C1005X7R272□GTS	C1005X7R272□GT	1V, 1kHz	2.7	nF	±5%, ±10%	0.50	±0.05	±0.05	3.0%		(I)
	C1005X7R332□GTS	C1005X7R332□GT	1V, 1kHz	3.3	nF	±5%, ±10%	0.50	±0.05	±0.05	3.0%		(I)
	C1005X7R392KGTS	C1005X7R392KGT	1V, 1kHz	3.9	nF	±10%	0.50	±0.05	±0.05	3.0%		(I)
	C1005X7R472□GTS	C1005X7R472□GT	1V, 1kHz	4.7	nF	±5%, ±10%	0.50	±0.05	±0.05	3.0%		(I)
	C1005X7R562□GTS	C1005X7R562□GT	1V, 1kHz	5.6	nF	±5%, ±10%	0.50	±0.05	±0.05	3.0%		(I)
	C1005X7R682□GTS	C1005X7R682□GT	1V, 1kHz	6.8	nF	±5%, ±10%	0.50	±0.05	±0.05	3.0%		(I)
	C1005X7R822KGTS	C1005X7R822KGT	1V, 1kHz	8.2	nF	±10%	0.50	±0.05	±0.05	3.0%		(I)
	C1005X7R103□GTS	C1005X7R103□GT	1V, 1kHz	10	nF	±5%, ±10%, ±20%	0.50	±0.05	±0.05	3.0%		(I)
	C1005X7R123KGTS	C1005X7R123KGT	1V, 1kHz	12	nF	±10%	0.50	±0.05	±0.05	3.0%		(I)
	C1005X7R153KGTS	C1005X7R153KGT	1V, 1kHz	15	nF	±10%	0.50	±0.05	±0.05	3.0%		(I)
	C1005X7R183KGTS	C1005X7R183KGT	1V, 1kHz	18	nF	±10%	0.50	±0.05	±0.05	3.0%		(I)
	C1005X7R223□GTS	C1005X7R223□GT	1V, 1kHz	22	nF	±5%, ±10%	0.50	±0.05	±0.05	3.0%		(I)
C1005X7R333KGTS	C1005X7R333KGT	1V, 1kHz	33	nF	±10%	0.50	±0.05	±0.05	3.5%	(I)		
C1005X7R393KGTS	C1005X7R393KGT	1V, 1kHz	39	nF	±10%	0.50	±0.05	±0.05	10.0%	(II)		
C1005X7R473KGTS	C1005X7R473KGT	1V, 1kHz	47	nF	±10%	0.50	±0.05	±0.05	10.0%	(II)		
C1005X7R683□GTS	C1005X7R683□GT	1V, 1kHz	68	nF	±5%, ±10%	0.50	±0.05	±0.05	10.0%	(II)		
C1005X7R104□GTS	C1005X7R104□GT	1V, 1kHz	100	nF	±10%, ±20%	0.50	±0.10	±0.10	10.0%	(II)		
35V	C1005X7R473KNFS	C1005X7R473KNFT	1V, 1kHz	47	nF	±10%	0.50	±0.05	±0.05	10.0%	Paper, 10Kpcs	(II)
25V	C1005X7R101KFSTS	C1005X7R101KFST	1V, 1kHz	100	pF	±10%	0.50	±0.05	±0.05	3.0%	Paper, 10Kpcs	(I)
	C1005X7R121KFSTS	C1005X7R121KFST	1V, 1kHz	120	pF	±10%	0.50	±0.05	±0.05	3.0%		(I)
	C1005X7R151KFSTS	C1005X7R151KFST	1V, 1kHz	150	pF	±10%	0.50	±0.05	±0.05	3.0%		(I)
	C1005X7R181KFSTS	C1005X7R181KFST	1V, 1kHz	180	pF	±10%	0.50	±0.05	±0.05	3.0%		(I)
	C1005X7R221KFSTS	C1005X7R221KFST	1V, 1kHz	220	pF	±10%	0.50	±0.05	±0.05	3.0%		(I)
	C1005X7R271KFSTS	C1005X7R271KFST	1V, 1kHz	270	pF	±10%	0.50	±0.05	±0.05	3.0%		(I)
	C1005X7R331KFSTS	C1005X7R331KFST	1V, 1kHz	330	pF	±10%	0.50	±0.05	±0.05	3.0%		(I)
	C1005X7R391KFSTS	C1005X7R391KFST	1V, 1kHz	390	pF	±10%	0.50	±0.05	±0.05	3.0%		(I)
	C1005X7R471KFSTS	C1005X7R471KFST	1V, 1kHz	470	pF	±10%	0.50	±0.05	±0.05	3.0%		(I)
	C1005X7R561KFSTS	C1005X7R561KFST	1V, 1kHz	560	pF	±10%	0.50	±0.05	±0.05	3.0%		(I)
	C1005X7R681KFSTS	C1005X7R681KFST	1V, 1kHz	680	pF	±10%	0.50	±0.05	±0.05	3.0%		(I)
	C1005X7R821KFSTS	C1005X7R821KFST	1V, 1kHz	820	pF	±10%	0.50	±0.05	±0.05	3.0%		(I)
	C1005X7R102□FSTS	C1005X7R102□FST	1V, 1kHz	1.0	nF	±5%, ±10%	0.50	±0.05	±0.05	3.0%		(I)
	C1005X7R122KFSTS	C1005X7R122KFST	1V, 1kHz	1.2	nF	±10%	0.50	±0.05	±0.05	3.0%		(I)
	C1005X7R152KFSTS	C1005X7R152KFST	1V, 1kHz	1.5	nF	±10%	0.50	±0.05	±0.05	3.0%		(I)
	C1005X7R182KFSTS	C1005X7R182KFST	1V, 1kHz	1.8	nF	±10%	0.50	±0.05	±0.05	3.0%		(I)
	C1005X7R222KFSTS	C1005X7R222KFST	1V, 1kHz	2.2	nF	±10%	0.50	±0.05	±0.05	3.0%		(I)
	C1005X7R272KFSTS	C1005X7R272KFST	1V, 1kHz	2.7	nF	±10%	0.50	±0.05	±0.05	3.0%		(I)
	C1005X7R332□FSTS	C1005X7R332□FST	1V, 1kHz	3.3	nF	±5%, ±10%	0.50	±0.05	±0.05	3.0%		(I)
	C1005X7R392KFSTS	C1005X7R392KFST	1V, 1kHz	3.9	nF	±10%	0.50	±0.05	±0.05	3.0%		(I)
	C1005X7R472□FSTS	C1005X7R472□FST	1V, 1kHz	4.7	nF	±5%, ±10%	0.50	±0.05	±0.05	3.0%		(I)
	C1005X7R562KFSTS	C1005X7R562KFST	1V, 1kHz	5.6	nF	±10%	0.50	±0.05	±0.05	3.0%		(I)
	C1005X7R682KFSTS	C1005X7R682KFST	1V, 1kHz	6.8	nF	±10%	0.50	±0.05	±0.05	3.0%		(I)
	C1005X7R822KFSTS	C1005X7R822KFST	1V, 1kHz	8.2	nF	±10%	0.50	±0.05	±0.05	3.0%		(I)
	C1005X7R103□FSTS	C1005X7R103□FST	1V, 1kHz	10	nF	±5%, ±10%	0.50	±0.05	±0.05	3.0%		(I)

RV	DARFON P/N	DARFON P/N 2	Measuring Condition	Capacitance		Available Tolerance	Thick. (mm)	Tolerance(mm)		DF (max.)	Standard Packing	Test Spec.
				Value	Unit			L/W	Thick.			
25V	C1005X7R123KF	C1005X7R123KFT	1V, 1kHz	12	nF	±10%	0.50	±0.05	±0.05	3.0%	Paper, 10Kpcs	(I)
	C1005X7R153□FTS	C1005X7R153□FT	1V, 1kHz	15	nF	±5%, ±10%	0.50	±0.05	±0.05	3.0%		(I)
	C1005X7R183KF	C1005X7R183KFT	1V, 1kHz	18	nF	±10%	0.50	±0.05	±0.05	3.0%		(I)
	C1005X7R223□FTS	C1005X7R223□FT	1V, 1kHz	22	nF	±5%, ±10%	0.50	±0.05	±0.05	3.0%		(I)
	C1005X7R273□FTS	C1005X7R273□FT	1V, 1kHz	27	nF	±10%, ±20%	0.50	±0.05	±0.05	3.5%		(I)
	C1005X7R333KF	C1005X7R333KFT	1V, 1kHz	33	nF	±10%	0.50	±0.05	±0.05	3.5%		(I)
	C1005X7R393KF	C1005X7R393KFT	1V, 1kHz	39	nF	±10%	0.50	±0.05	±0.05	3.5%		(I)
	C1005X7R473□FTS	C1005X7R473□FT	1V, 1kHz	47	nF	±5%, ±10%	0.50	±0.05	±0.05	3.5%		(I)
	C1005X7R563KF	C1005X7R563KFT	1V, 1kHz	56	nF	±10%	0.50	±0.05	±0.05	3.5%		(I)
	C1005X7R683KF	C1005X7R683KFT	1V, 1kHz	68	nF	±10%	0.50	±0.05	±0.05	3.5%		(I)
	C1005X7R104□FTS	C1005X7R104□FT	1V, 1kHz	100	nF	±10%, ±20%	0.50	±0.05	±0.05	10.0%		(II)
	C1005X7R224KF	C1005X7R224KFT	1V, 1kHz	220	nF	±10%	0.50	±0.10	±0.10	10.0%		(II)
C1005X7R334KF	C1005X7R334KFT	1V, 1kHz	330	nF	±10%	0.50	±0.15	±0.15	12.5%	(III)*		
16V	C1005X7R101KET	C1005X7R101KET	1V, 1kHz	100	pF	±10%	0.50	±0.05	±0.05	5.0%	Paper, 10Kpcs	(I)
	C1005X7R121KET	C1005X7R121KET	1V, 1kHz	120	pF	±10%	0.50	±0.05	±0.05	5.0%		(I)
	C1005X7R151KET	C1005X7R151KET	1V, 1kHz	150	pF	±10%	0.50	±0.05	±0.05	5.0%		(I)
	C1005X7R181KET	C1005X7R181KET	1V, 1kHz	180	pF	±10%	0.50	±0.05	±0.05	5.0%		(I)
	C1005X7R221□ETS	C1005X7R221□ET	1V, 1kHz	220	pF	±5%, ±10%	0.50	±0.05	±0.05	5.0%		(I)
	C1005X7R271KET	C1005X7R271KET	1V, 1kHz	270	pF	±10%	0.50	±0.05	±0.05	5.0%		(I)
	C1005X7R331KET	C1005X7R331KET	1V, 1kHz	330	pF	±10%	0.50	±0.05	±0.05	5.0%		(I)
	C1005X7R391KET	C1005X7R391KET	1V, 1kHz	390	pF	±10%	0.50	±0.05	±0.05	5.0%		(I)
	C1005X7R471KET	C1005X7R471KET	1V, 1kHz	470	pF	±10%	0.50	±0.05	±0.05	5.0%		(I)
	C1005X7R561KET	C1005X7R561KET	1V, 1kHz	560	pF	±10%	0.50	±0.05	±0.05	5.0%		(I)
	C1005X7R681KET	C1005X7R681KET	1V, 1kHz	680	pF	±10%	0.50	±0.05	±0.05	5.0%		(I)
	C1005X7R821KET	C1005X7R821KET	1V, 1kHz	820	pF	±10%	0.50	±0.05	±0.05	5.0%		(I)
	C1005X7R102□ETS	C1005X7R102□ET	1V, 1kHz	1.0	nF	±5%, ±10%	0.50	±0.05	±0.05	5.0%		(I)
	C1005X7R122KETS	C1005X7R122KET	1V, 1kHz	1.2	nF	±10%	0.50	±0.05	±0.05	5.0%		(I)
	C1005X7R152□ETS	C1005X7R152□ET	1V, 1kHz	1.5	nF	±5%, ±10%	0.50	±0.05	±0.05	5.0%		(I)
	C1005X7R182KETS	C1005X7R182KET	1V, 1kHz	1.8	nF	±10%	0.50	±0.05	±0.05	5.0%		(I)
	C1005X7R222□ETS	C1005X7R222□ET	1V, 1kHz	2.2	nF	±5%, ±10%	0.50	±0.05	±0.05	5.0%		(I)
	C1005X7R272KETS	C1005X7R272KET	1V, 1kHz	2.7	nF	±10%	0.50	±0.05	±0.05	5.0%		(I)
	C1005X7R332KETS	C1005X7R332KET	1V, 1kHz	3.3	nF	±10%	0.50	±0.05	±0.05	5.0%		(I)
	C1005X7R392KETS	C1005X7R392KET	1V, 1kHz	3.9	nF	±10%	0.50	±0.05	±0.05	5.0%		(I)
	C1005X7R472KETS	C1005X7R472KET	1V, 1kHz	4.7	nF	±10%	0.50	±0.05	±0.05	5.0%		(I)
	C1005X7R562KETS	C1005X7R562KET	1V, 1kHz	5.6	nF	±10%	0.50	±0.05	±0.05	5.0%		(I)
	C1005X7R682KETS	C1005X7R682KET	1V, 1kHz	6.8	nF	±10%	0.50	±0.05	±0.05	5.0%		(I)
	C1005X7R822KETS	C1005X7R822KET	1V, 1kHz	8.2	nF	±10%	0.50	±0.05	±0.05	5.0%		(I)
	C1005X7R103□ETS	C1005X7R103□ET	1V, 1kHz	10	nF	±5%, ±10%, ±20%	0.50	±0.05	±0.05	5.0%		(I)
	C1005X7R123KETS	C1005X7R123KET	1V, 1kHz	12	nF	±10%	0.50	±0.05	±0.05	5.0%		(I)
	C1005X7R153KETS	C1005X7R153KET	1V, 1kHz	15	nF	±10%	0.50	±0.05	±0.05	5.0%		(I)
	C1005X7R183KETS	C1005X7R183KET	1V, 1kHz	18	nF	±10%	0.50	±0.05	±0.05	5.0%		(I)
	C1005X7R223KETS	C1005X7R223KET	1V, 1kHz	22	nF	±10%	0.50	±0.05	±0.05	5.0%		(I)
	C1005X7R273KETS	C1005X7R273KET	1V, 1kHz	27	nF	±10%	0.50	±0.05	±0.05	5.0%		(I)
	C1005X7R333□ETS	C1005X7R333□ET	1V, 1kHz	33	nF	±5%, ±10%	0.50	±0.05	±0.05	5.0%		(I)
	C1005X7R393KETS	C1005X7R393KET	1V, 1kHz	39	nF	±10%	0.50	±0.05	±0.05	5.0%		(I)
	C1005X7R473□ETS	C1005X7R473□ET	1V, 1kHz	47	nF	±10%, ±20%	0.50	±0.05	±0.05	5.0%		(I)
	C1005X7R563KETS	C1005X7R563KET	1V, 1kHz	56	nF	±10%	0.50	±0.05	±0.05	5.0%		(I)
	C1005X7R683KETS	C1005X7R683KET	1V, 1kHz	68	nF	±10%	0.50	±0.05	±0.05	5.0%		(I)
	C1005X7R823KETS	C1005X7R823KET	1V, 1kHz	82	nF	±10%	0.50	±0.05	±0.05	5.0%		(I)
C1005X7R104□ETS	C1005X7R104□ET	1V, 1kHz	100	nF	±5%, ±10%, ±20%	0.50	±0.05	±0.05	5.0%	(I)		
C1005X7R154□ETS	C1005X7R154□ET	1V, 1kHz	150	nF	±10%, ±20%	0.50	±0.05	±0.05	10.0%	(II)		
C1005X7R224□ETS	C1005X7R224□ET	1V, 1kHz	220	nF	±10%, ±20%	0.50	±0.10	±0.10	10.0%	(II)		
C1005X7R334KETS	C1005X7R334KET	1V, 1kHz	330	nF	±10%	0.50	±0.10	±0.10	12.5%	(III)*		
C1005X7R474KETS	C1005X7R474KET	1V, 1kHz	470	nF	±10%	0.50	±0.10	±0.10	12.5%	(III)*		
C1005X7R105KETS	C1005X7R105KET	1V, 1kHz	1.0	uF	±10%	0.50	±0.10	±0.10	12.5%	(III)*		
10V	C1005X7R101KDT	C1005X7R101KDT	1V, 1kHz	100	pF	±10%	0.50	±0.05	±0.05	5.0%	Paper, 10Kpcs	(I)
	C1005X7R121KDT	C1005X7R121KDT	1V, 1kHz	120	pF	±10%	0.50	±0.05	±0.05	5.0%		(I)
	C1005X7R151KDT	C1005X7R151KDT	1V, 1kHz	150	pF	±10%	0.50	±0.05	±0.05	5.0%		(I)
	C1005X7R181KDT	C1005X7R181KDT	1V, 1kHz	180	pF	±10%	0.50	±0.05	±0.05	5.0%		(I)
	C1005X7R221KDT	C1005X7R221KDT	1V, 1kHz	220	pF	±10%	0.50	±0.05	±0.05	5.0%		(I)
	C1005X7R271KDT	C1005X7R271KDT	1V, 1kHz	270	pF	±10%	0.50	±0.05	±0.05	5.0%		(I)
	C1005X7R331KDT	C1005X7R331KDT	1V, 1kHz	330	pF	±10%	0.50	±0.05	±0.05	5.0%		(I)
	C1005X7R391KDT	C1005X7R391KDT	1V, 1kHz	390	pF	±10%	0.50	±0.05	±0.05	5.0%		(I)
	C1005X7R471KDT	C1005X7R471KDT	1V, 1kHz	470	pF	±10%	0.50	±0.05	±0.05	5.0%		(I)
	C1005X7R561KDT	C1005X7R561KDT	1V, 1kHz	560	pF	±10%	0.50	±0.05	±0.05	5.0%		(I)
	C1005X7R681KDT	C1005X7R681KDT	1V, 1kHz	680	pF	±10%	0.50	±0.05	±0.05	5.0%		(I)
	C1005X7R821KDT	C1005X7R821KDT	1V, 1kHz	820	pF	±10%	0.50	±0.05	±0.05	5.0%		(I)
	C1005X7R102KDT	C1005X7R102KDT	1V, 1kHz	1.0	nF	±10%	0.50	±0.05	±0.05	5.0%		(I)

MLCC
General Purpose

RV	DARFON P/N	DARFON P/N 2	Measuring Condition	Capacitance		Available Tolerance	Thick. (mm)	Tolerance(mm)		DF (max.)	Standard Packing	Test Spec.
				Value	Unit			L/W	Thick.			
10V	C1005X7R122KDTS	C1005X7R122KDT	1V , 1kHz	1.2	nF	±10%	0.50	±0.05	±0.05	5.0%	Paper, 10Kpcs	(I)
	C1005X7R152KDTS	C1005X7R152KDT	1V , 1kHz	1.5	nF	±10%	0.50	±0.05	±0.05	5.0%		(I)
	C1005X7R182KDTS	C1005X7R182KDT	1V , 1kHz	1.8	nF	±10%	0.50	±0.05	±0.05	5.0%		(I)
	C1005X7R222KDTS	C1005X7R222KDT	1V , 1kHz	2.2	nF	±10%	0.50	±0.05	±0.05	5.0%		(I)
	C1005X7R272KDTS	C1005X7R272KDT	1V , 1kHz	2.7	nF	±10%	0.50	±0.05	±0.05	5.0%		(I)
	C1005X7R332KDTS	C1005X7R332KDT	1V , 1kHz	3.3	nF	±10%	0.50	±0.05	±0.05	5.0%		(I)
	C1005X7R392KDTS	C1005X7R392KDT	1V , 1kHz	3.9	nF	±10%	0.50	±0.05	±0.05	5.0%		(I)
	C1005X7R472KDTS	C1005X7R472KDT	1V , 1kHz	4.7	nF	±10%	0.50	±0.05	±0.05	5.0%		(I)
	C1005X7R562KDTS	C1005X7R562KDT	1V , 1kHz	5.6	nF	±10%	0.50	±0.05	±0.05	5.0%		(I)
	C1005X7R682KDTS	C1005X7R682KDT	1V , 1kHz	6.8	nF	±10%	0.50	±0.05	±0.05	5.0%		(I)
	C1005X7R822KDTS	C1005X7R822KDT	1V , 1kHz	8.2	nF	±10%	0.50	±0.05	±0.05	5.0%		(I)
	C1005X7R103KDTS	C1005X7R103KDT	1V , 1kHz	10	nF	±10%	0.50	±0.05	±0.05	5.0%		(I)
	C1005X7R123KDTS	C1005X7R123KDT	1V , 1kHz	12	nF	±10%	0.50	±0.05	±0.05	5.0%		(I)
	C1005X7R153KDTS	C1005X7R153KDT	1V , 1kHz	15	nF	±10%	0.50	±0.05	±0.05	5.0%		(I)
	C1005X7R183KDTS	C1005X7R183KDT	1V , 1kHz	18	nF	±10%	0.50	±0.05	±0.05	5.0%		(I)
	C1005X7R223KDTS	C1005X7R223KDT	1V , 1kHz	22	nF	±10%	0.50	±0.05	±0.05	5.0%		(I)
	C1005X7R273KDTS	C1005X7R273KDT	1V , 1kHz	27	nF	±10%	0.50	±0.05	±0.05	5.0%		(I)
	C1005X7R333KDTS	C1005X7R333KDT	1V , 1kHz	33	nF	±10%	0.50	±0.05	±0.05	5.0%		(I)
	C1005X7R393KDTS	C1005X7R393KDT	1V , 1kHz	39	nF	±10%	0.50	±0.05	±0.05	5.0%		(I)
	C1005X7R473KDTS	C1005X7R473KDT	1V , 1kHz	47	nF	±10%	0.50	±0.05	±0.05	5.0%		(I)
	C1005X7R563KDTS	C1005X7R563KDT	1V , 1kHz	56	nF	±10%	0.50	±0.05	±0.05	5.0%		(I)
	C1005X7R683KDTS	C1005X7R683KDT	1V , 1kHz	68	nF	±10%	0.50	±0.05	±0.05	5.0%		(I)
	C1005X7R823KDTS	C1005X7R823KDT	1V , 1kHz	82	nF	±10%	0.50	±0.05	±0.05	5.0%		(I)
	C1005X7R104□DTS	C1005X7R104□DT	1V , 1kHz	100	nF	±5%, ±10%	0.50	±0.05	±0.05	5.0%		(I)
	C1005X7R224KDTS	C1005X7R224KDT	1V , 1kHz	220	nF	±10%	0.50	±0.10	±0.10	10.0%		(II)
	C1005X7R334KDTS	C1005X7R334KDT	1V , 1kHz	330	nF	±10%	0.50	±0.10	±0.10	10.0%		(II)
C1005X7R474KDTS	C1005X7R474KDT	1V , 1kHz	470	nF	±10%	0.50	±0.10	±0.10	10.0%	(II)		
C1005X7R684KDTS	C1005X7R684KDT	1V , 1kHz	680	nF	±10%	0.50	±0.10	±0.10	10.0%	(II)*		
C1005X7R105KDTS	C1005X7R105KDT	1V , 1kHz	1.0	uF	±10%	0.50	±0.10	±0.10	10.0%	(II)*		
C1005X7R225KDTS	C1005X7R225KDT	1V , 1kHz	2.2	uF	±10%	0.50	±0.20	±0.20	15.0%	(II)*		
6.3V	C1005X7R103KCTS	C1005X7R103KCT	1V , 1kHz	10	nF	±10%	0.50	±0.05	±0.05	5.0%	Paper, 10Kpcs	(I)
	C1005X7R223KCTS	C1005X7R223KCT	1V , 1kHz	22	nF	±10%	0.50	±0.05	±0.05	5.0%		(I)
	C1005X7R473KCTS	C1005X7R473KCT	1V , 1kHz	47	nF	±10%	0.50	±0.05	±0.05	5.0%		(I)
	C1005X7R683KCTS	C1005X7R683KCT	1V , 1kHz	68	nF	±10%	0.50	±0.05	±0.05	5.0%		(I)
	C1005X7R104□CTS	C1005X7R104□CT	1V , 1kHz	100	nF	±5%, ±10%	0.50	±0.05	±0.05	5.0%		(I)
	C1005X7R224KCTS	C1005X7R224KCT	1V , 1kHz	220	nF	±10%	0.50	±0.10	±0.10	10.0%		(II)
	C1005X7R334KCTS	C1005X7R334KCT	1V , 1kHz	330	nF	±10%	0.50	±0.10	±0.10	10.0%		(II)
	C1005X7R474□CTS	C1005X7R474□CT	1V , 1kHz	470	nF	±10%, ±20%	0.50	±0.10	±0.10	10.0%		(II)
	C1005X7R105□CTS	C1005X7R105□CT	1V , 1kHz	1.0	uF	±10%, ±20%	0.50	±0.05	±0.05	12.5%		(II)*
C1005X7R225KCTS	C1005X7R225KCT	1V , 1kHz	2.2	uF	±10%	0.50	±0.20	±0.20	15.0%	(II)*		

□ Tolerance Code: J=±5%, K=±10%, M=±20%; Special tolerance on the request.

(II)* High temperature load life test are applicable in rated voltage *100%. (II)/(II)* are applied with derating voltage.

● C1608X7R Series (EIA0603)

RV	DARFON P/N	DARFON P/N 2	Measuring Condition	Capacitance		Available Tolerance	Thick. (mm)	Tolerance(mm)		DF (max.)	Standard Packing	Test Spec.
				Value	Unit			L/W	Thick.			
50V	C1608X7R101KGTS	C1608X7R101KGT	1V, 1kHz	100	pF	±10%	0.80	±0.10	±0.10	2.5%	Paper, 4Kpcs	(I)
	C1608X7R121KGTS	C1608X7R121KGT	1V, 1kHz	120	pF	±10%	0.80	±0.10	±0.10	2.5%		(I)
	C1608X7R151KGTS	C1608X7R151KGT	1V, 1kHz	150	pF	±10%	0.80	±0.10	±0.10	2.5%		(I)
	C1608X7R181KGTS	C1608X7R181KGT	1V, 1kHz	180	pF	±10%	0.80	±0.10	±0.10	2.5%		(I)
	C1608X7R221KGTS	C1608X7R221KGT	1V, 1kHz	220	pF	±10%	0.80	±0.10	±0.10	2.5%		(I)
	C1608X7R271KGTS	C1608X7R271KGT	1V, 1kHz	270	pF	±10%	0.80	±0.10	±0.10	2.5%		(I)
	C1608X7R331KGTS	C1608X7R331KGT	1V, 1kHz	330	pF	±10%	0.80	±0.10	±0.10	2.5%		(I)
	C1608X7R391KGTS	C1608X7R391KGT	1V, 1kHz	390	pF	±10%	0.80	±0.10	±0.10	2.5%		(I)
	C1608X7R471□GTS	C1608X7R471□GT	1V, 1kHz	470	pF	±10%, ±20%	0.80	±0.10	±0.10	2.5%		(I)
	C1608X7R561KGTS	C1608X7R561KGT	1V, 1kHz	560	pF	±10%	0.80	±0.10	±0.10	2.5%		(I)
	C1608X7R681KGTS	C1608X7R681KGT	1V, 1kHz	680	pF	±10%	0.80	±0.10	±0.10	2.5%		(I)
	C1608X7R821KGTS	C1608X7R821KGT	1V, 1kHz	820	pF	±10%	0.80	±0.10	±0.10	2.5%		(I)
	C1608X7R102□GTS	C1608X7R102□GT	1V, 1kHz	1.0	nF	±5%, ±10%	0.80	±0.10	±0.10	2.5%		(I)
	C1608X7R122□GTS	C1608X7R122□GT	1V, 1kHz	1.2	nF	±5%, ±10%	0.80	±0.10	±0.10	2.5%		(I)
	C1608X7R152□GTS	C1608X7R152□GT	1V, 1kHz	1.5	nF	±5%, ±10%	0.80	±0.10	±0.10	2.5%		(I)
	C1608X7R182KGTS	C1608X7R182KGT	1V, 1kHz	1.8	nF	±10%	0.80	±0.10	±0.10	2.5%		(I)
	C1608X7R202KGTS	C1608X7R202KGT	1V, 1kHz	2.0	nF	±10%	0.80	±0.10	±0.10	2.5%		(I)
	C1608X7R222KGTS	C1608X7R222KGT	1V, 1kHz	2.2	nF	±10%	0.80	±0.10	±0.10	2.5%		(I)
	C1608X7R272KGTS	C1608X7R272KGT	1V, 1kHz	2.7	nF	±10%	0.80	±0.10	±0.10	2.5%		(I)
	C1608X7R332□GTS	C1608X7R332□GT	1V, 1kHz	3.3	nF	±5%, ±10%	0.80	±0.10	±0.10	2.5%		(I)
	C1608X7R392KGTS	C1608X7R392KGT	1V, 1kHz	3.9	nF	±10%	0.80	±0.10	±0.10	2.5%		(I)
	C1608X7R472□GTS	C1608X7R472□GT	1V, 1kHz	4.7	nF	±5%, ±10%	0.80	±0.10	±0.10	2.5%		(I)
	C1608X7R562KGTS	C1608X7R562KGT	1V, 1kHz	5.6	nF	±10%	0.80	±0.10	±0.10	2.5%		(I)
	C1608X7R682□GTS	C1608X7R682□GT	1V, 1kHz	6.8	nF	±5%, ±10%	0.80	±0.10	±0.10	2.5%		(I)
	C1608X7R822KGTS	C1608X7R822KGT	1V, 1kHz	8.2	nF	±10%	0.80	±0.10	±0.10	2.5%		(I)
	C1608X7R103□GTS	C1608X7R103□GT	1V, 1kHz	10	nF	±5%, ±10%, ±20%	0.80	±0.10	±0.10	2.5%		(I)
	C1608X7R123KGTS	C1608X7R123KGT	1V, 1kHz	12	nF	±10%	0.80	±0.10	±0.10	2.5%		(I)
	C1608X7R153KGTS	C1608X7R153KGT	1V, 1kHz	15	nF	±10%	0.80	±0.10	±0.10	2.5%		(I)
	C1608X7R183□GTS	C1608X7R183□GT	1V, 1kHz	18	nF	±5%, ±10%	0.80	±0.10	±0.10	2.5%		(I)
	C1608X7R223KGTS	C1608X7R223KGT	1V, 1kHz	22	nF	±10%	0.80	±0.10	±0.10	2.5%		(I)
	C1608X7R273KGTS	C1608X7R273KGT	1V, 1kHz	27	nF	±10%	0.80	±0.10	±0.10	2.5%		(I)
	C1608X7R333KGTS	C1608X7R333KGT	1V, 1kHz	33	nF	±10%	0.80	±0.15	±0.15	2.5%		(I)
	C1608X7R393KGTS	C1608X7R393KGT	1V, 1kHz	39	nF	±10%	0.80	±0.15	±0.15	2.5%		(I)
	C1608X7R473KGTS	C1608X7R473KGT	1V, 1kHz	47	nF	±10%	0.80	±0.15	±0.15	3.0%		(I)
	C1608X7R563KGTS	C1608X7R563KGT	1V, 1kHz	56	nF	±10%	0.80	±0.15	±0.15	3.0%		(I)
	C1608X7R683KGTS	C1608X7R683KGT	1V, 1kHz	68	nF	±10%	0.80	±0.15	±0.15	3.0%		(I)
C1608X7R823KGTS	C1608X7R823KGT	1V, 1kHz	82	nF	±10%	0.80	±0.15	±0.15	3.0%	(I)		
C1608X7R104□GTS	C1608X7R104□GT	1V, 1kHz	100	nF	±5%, ±10%, ±20%	0.80	±0.15	±0.15	3.0%	(II)		
C1608X7R154KGTS	C1608X7R154KGT	1V, 1kHz	150	nF	±10%	0.80	±0.15	±0.15	3.5%	(II)		
C1608X7R224□GTS	C1608X7R224□GT	1V, 1kHz	220	nF	±5%, ±10%	0.80	±0.15	±0.15	3.5%	(II)		
C1608X7R334KGTS	C1608X7R334KGT	1V, 1kHz	330	nF	±10%	0.80	±0.15	±0.15	10.0%	(II)		
C1608X7R474KGTS	C1608X7R474KGT	1V, 1kHz	470	nF	±10%	0.80	±0.15	±0.15	10.0%	(II)		
C1608X7R105KGTS	C1608X7R105KGT	1V, 1kHz	1.0	uF	±10%	0.80	±0.20	±0.20	10.0%	(II)		
35V	C1608X7R474KNTS	C1608X7R474KNT	1V, 1kHz	470	nF	±10%	0.80	±0.15	±0.15	10.0%	Paper, 4Kpcs	(II)
	C1608X7R105KNTS	C1608X7R105KNT	1V, 1kHz	1.0	uF	±10%	0.80	±0.20	±0.20	10.0%		(II)
	C1608X7R101KFSTS	C1608X7R101KFT	1V, 1kHz	100	pF	±10%	0.80	±0.10	±0.10	3.5%		(I)
25V	C1608X7R121KFSTS	C1608X7R121KFT	1V, 1kHz	120	pF	±10%	0.80	±0.10	±0.10	3.5%	Paper, 4Kpcs	(I)
	C1608X7R151KFSTS	C1608X7R151KFT	1V, 1kHz	150	pF	±10%	0.80	±0.10	±0.10	3.5%		(I)
	C1608X7R181KFSTS	C1608X7R181KFT	1V, 1kHz	180	pF	±10%	0.80	±0.10	±0.10	3.5%		(I)
	C1608X7R221KFSTS	C1608X7R221KFT	1V, 1kHz	220	pF	±10%	0.80	±0.10	±0.10	3.5%		(I)
	C1608X7R271KFSTS	C1608X7R271KFT	1V, 1kHz	270	pF	±10%	0.80	±0.10	±0.10	3.5%		(I)
	C1608X7R331KFSTS	C1608X7R331KFT	1V, 1kHz	330	pF	±10%	0.80	±0.10	±0.10	3.5%		(I)
	C1608X7R391KFSTS	C1608X7R391KFT	1V, 1kHz	390	pF	±10%	0.80	±0.10	±0.10	3.5%		(I)
	C1608X7R471KFSTS	C1608X7R471KFT	1V, 1kHz	470	pF	±10%	0.80	±0.10	±0.10	3.5%		(I)
	C1608X7R561KFSTS	C1608X7R561KFT	1V, 1kHz	560	pF	±10%	0.80	±0.10	±0.10	3.5%		(I)
	C1608X7R681KFSTS	C1608X7R681KFT	1V, 1kHz	680	pF	±10%	0.80	±0.10	±0.10	3.5%		(I)
	C1608X7R821KFSTS	C1608X7R821KFT	1V, 1kHz	820	pF	±10%	0.80	±0.10	±0.10	3.5%		(I)
	C1608X7R102KFSTS	C1608X7R102KFT	1V, 1kHz	1.0	nF	±10%	0.80	±0.10	±0.10	3.5%		(I)
	C1608X7R122KFSTS	C1608X7R122KFT	1V, 1kHz	1.2	nF	±10%	0.80	±0.10	±0.10	3.5%		(I)
	C1608X7R152KFSTS	C1608X7R152KFT	1V, 1kHz	1.5	nF	±10%	0.80	±0.10	±0.10	3.5%		(I)
	C1608X7R182KFSTS	C1608X7R182KFT	1V, 1kHz	1.8	nF	±10%	0.80	±0.10	±0.10	3.5%		(I)
	C1608X7R222KFSTS	C1608X7R222KFT	1V, 1kHz	2.2	nF	±10%	0.80	±0.10	±0.10	3.5%		(I)
	C1608X7R272KFSTS	C1608X7R272KFT	1V, 1kHz	2.7	nF	±10%	0.80	±0.10	±0.10	3.5%		(I)
	C1608X7R332KFSTS	C1608X7R332KFT	1V, 1kHz	3.3	nF	±10%	0.80	±0.10	±0.10	3.5%		(I)
	C1608X7R392KFSTS	C1608X7R392KFT	1V, 1kHz	3.9	nF	±10%	0.80	±0.10	±0.10	3.5%		(I)
	C1608X7R472KFSTS	C1608X7R472KFT	1V, 1kHz	4.7	nF	±10%	0.80	±0.10	±0.10	3.5%		(I)

MLCC

General Purpose

RV	DARFON P/N	DARFON P/N 2	Measuring Condition	Capacitance		Available Tolerance	Thick. (mm)	Tolerance(mm)		DF (max.)	Standard Packing	Test Spec.
				Value	Unit			L/W	Thick.			
25V	C1608X7R562KF	C1608X7R562KFT	1V, 1kHz	5.6	nF	±10%	0.80	±0.10	±0.10	3.5%	Paper, 4Kpcs	(I)
	C1608X7R682KF	C1608X7R682KFT	1V, 1kHz	6.8	nF	±10%	0.80	±0.10	±0.10	3.5%		(I)
	C1608X7R822KF	C1608X7R822KFT	1V, 1kHz	8.2	nF	±10%	0.80	±0.10	±0.10	3.5%		(I)
	C1608X7R103KF	C1608X7R103KFT	1V, 1kHz	10	nF	±5%, ±10%	0.80	±0.10	±0.10	3.5%		(I)
	C1608X7R123KF	C1608X7R123KFT	1V, 1kHz	12	nF	±10%	0.80	±0.10	±0.10	3.5%		(I)
	C1608X7R153KF	C1608X7R153KFT	1V, 1kHz	15	nF	±10%	0.80	±0.10	±0.10	3.5%		(I)
	C1608X7R183KF	C1608X7R183KFT	1V, 1kHz	18	nF	±10%	0.80	±0.10	±0.10	3.5%		(I)
	C1608X7R223KF	C1608X7R223KFT	1V, 1kHz	22	nF	±5%, ±10%	0.80	±0.10	±0.10	3.5%		(I)
	C1608X7R273KF	C1608X7R273KFT	1V, 1kHz	27	nF	±5%, ±10%	0.80	±0.10	±0.10	3.5%		(I)
	C1608X7R333KF	C1608X7R333KFT	1V, 1kHz	33	nF	±10%	0.80	±0.10	±0.10	3.5%		(I)
	C1608X7R393KF	C1608X7R393KFT	1V, 1kHz	39	nF	±10%	0.80	±0.10	±0.10	3.5%		(I)
	C1608X7R473KF	C1608X7R473KFT	1V, 1kHz	47	nF	±10%	0.80	±0.10	±0.10	3.5%		(I)
	C1608X7R563KF	C1608X7R563KFT	1V, 1kHz	56	nF	±10%	0.80	±0.10	±0.10	3.5%		(I)
	C1608X7R683KF	C1608X7R683KFT	1V, 1kHz	68	nF	±10%	0.80	±0.10	±0.10	3.5%		(I)
	C1608X7R823KF	C1608X7R823KFT	1V, 1kHz	82	nF	±10%	0.80	±0.10	±0.10	3.5%		(I)
	C1608X7R104KF	C1608X7R104KFT	1V, 1kHz	100	nF	±5%, ±10%	0.80	±0.10	±0.10	3.5%		(I)
	C1608X7R124KF	C1608X7R124KFT	1V, 1kHz	120	nF	±10%	0.80	±0.15	±0.15	3.5%		(I)
	C1608X7R154KF	C1608X7R154KFT	1V, 1kHz	150	nF	±10%	0.80	±0.15	±0.15	3.5%		(I)
	C1608X7R184KF	C1608X7R184KFT	1V, 1kHz	180	nF	±10%	0.80	±0.15	±0.15	3.5%		(I)
	C1608X7R224KF	C1608X7R224KFT	1V, 1kHz	220	nF	±10%, ±20%	0.80	±0.15	±0.15	3.5%		(I)
C1608X7R334KF	C1608X7R334KFT	1V, 1kHz	330	nF	±10%	0.80	±0.15	±0.15	7.0%	(I)		
C1608X7R394KF	C1608X7R394KFT	1V, 1kHz	390	nF	±10%	0.80	±0.15	±0.15	10.0%	(I)		
C1608X7R474KF	C1608X7R474KFT	1V, 1kHz	470	nF	±10%, ±20%	0.80	±0.15	±0.15	10.0%	(I)		
C1608X7R564KF	C1608X7R564KFT	1V, 1kHz	560	nF	±10%	0.80	±0.15	±0.15	10.0%	(II)		
C1608X7R105KF	C1608X7R105KFT	1V, 1kHz	1.0	uF	±10%	0.80	±0.15	±0.15	10.0%	(II)		
C1608X7R225KF	C1608X7R225KFT	1V, 1kHz	2.2	uF	±10%	0.80	±0.20	±0.20	10.0%	(III)*		
16V	C1608X7R101KET	C1608X7R101KET	1V, 1kHz	100	pF	±10%	0.80	±0.10	±0.10	5.0%	Paper, 4Kpcs	(I)
	C1608X7R121KET	C1608X7R121KET	1V, 1kHz	120	pF	±10%	0.80	±0.10	±0.10	5.0%		(I)
	C1608X7R151KET	C1608X7R151KET	1V, 1kHz	150	pF	±10%	0.80	±0.10	±0.10	5.0%		(I)
	C1608X7R181KET	C1608X7R181KET	1V, 1kHz	180	pF	±10%	0.80	±0.10	±0.10	5.0%		(I)
	C1608X7R221KET	C1608X7R221KET	1V, 1kHz	220	pF	±10%	0.80	±0.10	±0.10	5.0%		(I)
	C1608X7R271KET	C1608X7R271KET	1V, 1kHz	270	pF	±10%	0.80	±0.10	±0.10	5.0%		(I)
	C1608X7R331KET	C1608X7R331KET	1V, 1kHz	330	pF	±10%	0.80	±0.10	±0.10	5.0%		(I)
	C1608X7R391KET	C1608X7R391KET	1V, 1kHz	390	pF	±5%, ±10%	0.80	±0.10	±0.10	5.0%		(I)
	C1608X7R471KET	C1608X7R471KET	1V, 1kHz	470	pF	±10%	0.80	±0.10	±0.10	5.0%		(I)
	C1608X7R561KET	C1608X7R561KET	1V, 1kHz	560	pF	±10%	0.80	±0.10	±0.10	5.0%		(I)
	C1608X7R681KET	C1608X7R681KET	1V, 1kHz	680	pF	±10%	0.80	±0.10	±0.10	5.0%		(I)
	C1608X7R821KET	C1608X7R821KET	1V, 1kHz	820	pF	±10%	0.80	±0.10	±0.10	5.0%		(I)
	C1608X7R102KET	C1608X7R102KET	1V, 1kHz	1.0	nF	±10%	0.80	±0.10	±0.10	5.0%		(I)
	C1608X7R122KET	C1608X7R122KET	1V, 1kHz	1.2	nF	±10%	0.80	±0.10	±0.10	5.0%		(I)
	C1608X7R152KET	C1608X7R152KET	1V, 1kHz	1.5	nF	±10%	0.80	±0.10	±0.10	5.0%		(I)
	C1608X7R182KET	C1608X7R182KET	1V, 1kHz	1.8	nF	±10%	0.80	±0.10	±0.10	5.0%		(I)
	C1608X7R222KET	C1608X7R222KET	1V, 1kHz	2.2	nF	±10%	0.80	±0.10	±0.10	5.0%		(I)
	C1608X7R272KET	C1608X7R272KET	1V, 1kHz	2.7	nF	±10%	0.80	±0.10	±0.10	5.0%		(I)
	C1608X7R332KET	C1608X7R332KET	1V, 1kHz	3.3	nF	±10%	0.80	±0.10	±0.10	5.0%		(I)
	C1608X7R392KET	C1608X7R392KET	1V, 1kHz	3.9	nF	±10%	0.80	±0.10	±0.10	5.0%		(I)
	C1608X7R472KET	C1608X7R472KET	1V, 1kHz	4.7	nF	±10%	0.80	±0.10	±0.10	5.0%		(I)
	C1608X7R562KET	C1608X7R562KET	1V, 1kHz	5.6	nF	±10%	0.80	±0.10	±0.10	5.0%		(I)
	C1608X7R682KET	C1608X7R682KET	1V, 1kHz	6.8	nF	±10%	0.80	±0.10	±0.10	5.0%		(I)
	C1608X7R822KET	C1608X7R822KET	1V, 1kHz	8.2	nF	±10%	0.80	±0.10	±0.10	5.0%		(I)
	C1608X7R103KET	C1608X7R103KET	1V, 1kHz	10	nF	±10%	0.80	±0.10	±0.10	5.0%		(I)
	C1608X7R123KET	C1608X7R123KET	1V, 1kHz	12	nF	±10%	0.80	±0.10	±0.10	5.0%		(I)
	C1608X7R153KET	C1608X7R153KET	1V, 1kHz	15	nF	±10%	0.80	±0.10	±0.10	5.0%		(I)
	C1608X7R183KET	C1608X7R183KET	1V, 1kHz	18	nF	±10%	0.80	±0.10	±0.10	5.0%		(I)
	C1608X7R223KET	C1608X7R223KET	1V, 1kHz	22	nF	±10%	0.80	±0.10	±0.10	5.0%		(I)
	C1608X7R273KET	C1608X7R273KET	1V, 1kHz	27	nF	±10%	0.80	±0.10	±0.10	5.0%		(I)
	C1608X7R333KET	C1608X7R333KET	1V, 1kHz	33	nF	±10%	0.80	±0.10	±0.10	5.0%		(I)
	C1608X7R393KET	C1608X7R393KET	1V, 1kHz	39	nF	±10%	0.80	±0.10	±0.10	5.0%		(I)
C1608X7R473KET	C1608X7R473KET	1V, 1kHz	47	nF	±10%	0.80	±0.10	±0.10	5.0%	(I)		
C1608X7R563KET	C1608X7R563KET	1V, 1kHz	56	nF	±10%	0.80	±0.10	±0.10	5.0%	(I)		
C1608X7R683KET	C1608X7R683KET	1V, 1kHz	68	nF	±10%	0.80	±0.10	±0.10	5.0%	(I)		
C1608X7R823KET	C1608X7R823KET	1V, 1kHz	82	nF	±10%	0.80	±0.10	±0.10	5.0%	(I)		
C1608X7R104KET	C1608X7R104KET	1V, 1kHz	100	nF	±10%	0.80	±0.10	±0.10	5.0%	(I)		
C1608X7R124KET	C1608X7R124KET	1V, 1kHz	120	nF	±10%	0.80	±0.10	±0.10	5.0%	(I)		
C1608X7R154KET	C1608X7R154KET	1V, 1kHz	150	nF	±10%	0.80	±0.10	±0.10	5.0%	(I)		
C1608X7R184KET	C1608X7R184KET	1V, 1kHz	180	nF	±10%	0.80	±0.15	±0.15	5.0%	(I)		
C1608X7R224KET	C1608X7R224KET	1V, 1kHz	220	nF	±10%	0.80	±0.15	±0.15	5.0%	(I)		
C1608X7R334KET	C1608X7R334KET	1V, 1kHz	330	nF	±10%	0.80	±0.15	±0.15	5.0%	(I)		
C1608X7R474KET	C1608X7R474KET	1V, 1kHz	470	nF	±10%	0.80	±0.15	±0.15	5.0%	(I)		
C1608X7R684KET	C1608X7R684KET	1V, 1kHz	680	nF	±10%	0.80	±0.15	±0.15	10.0%	(I)		
C1608X7R105KET	C1608X7R105KET	1V, 1kHz	1.0	uF	±10%, ±20%	0.80	±0.15	±0.15	10.0%	(II)		
C1608X7R225KET	C1608X7R225KET	1V, 1kHz	2.2	uF	±10%, ±20%	0.80	±0.20	±0.20	10.0%	(II)		
C1608X7R475KET	C1608X7R475KET	1V, 1kHz	4.7	uF	±10%, ±20%	0.80	±0.20	±0.20	10.0%	(II)		

□ Tolerance Code: K=±10%, M=±20% ;Special tolerance on the request.

(II)* High temperature load life test are applicable in rated voltage *100%. (II)/(II)* are applied with derating voltage.

RV	DARFON P/N	DARFON P/N 2	Measuring Condition	Capacitance		Available Tolerance	Thick. (mm)	Tolerance(mm)		DF (max.)	Standard Packing	Test Spec.
				Value	Unit			L/W	Thick.			
10V	C1608X7R101KDTS	C1608X7R101KDT	1V, 1kHz	100	pF	±10%	0.80	±0.10	±0.10	5.0%	Paper, 4Kpcs	(I)
	C1608X7R121KDTS	C1608X7R121KDT	1V, 1kHz	120	pF	±10%	0.80	±0.10	±0.10	5.0%		(I)
	C1608X7R151KDTS	C1608X7R151KDT	1V, 1kHz	150	pF	±10%	0.80	±0.10	±0.10	5.0%		(I)
	C1608X7R181KDTS	C1608X7R181KDT	1V, 1kHz	180	pF	±10%	0.80	±0.10	±0.10	5.0%		(I)
	C1608X7R221KDTS	C1608X7R221KDT	1V, 1kHz	220	pF	±10%	0.80	±0.10	±0.10	5.0%		(I)
	C1608X7R271KDTS	C1608X7R271KDT	1V, 1kHz	270	pF	±10%	0.80	±0.10	±0.10	5.0%		(I)
	C1608X7R331KDTS	C1608X7R331KDT	1V, 1kHz	330	pF	±10%	0.80	±0.10	±0.10	5.0%		(I)
	C1608X7R391KDTS	C1608X7R391KDT	1V, 1kHz	390	pF	±10%	0.80	±0.10	±0.10	5.0%		(I)
	C1608X7R471KDTS	C1608X7R471KDT	1V, 1kHz	470	pF	±10%	0.80	±0.10	±0.10	5.0%		(I)
	C1608X7R561KDTS	C1608X7R561KDT	1V, 1kHz	560	pF	±10%	0.80	±0.10	±0.10	5.0%		(I)
	C1608X7R681KDTS	C1608X7R681KDT	1V, 1kHz	680	pF	±10%	0.80	±0.10	±0.10	5.0%		(I)
	C1608X7R821KDTS	C1608X7R821KDT	1V, 1kHz	820	pF	±10%	0.80	±0.10	±0.10	5.0%		(I)
	C1608X7R102KDTS	C1608X7R102KDT	1V, 1kHz	1.0	nF	±10%	0.80	±0.10	±0.10	5.0%		(I)
	C1608X7R122KDTS	C1608X7R122KDT	1V, 1kHz	1.2	nF	±10%	0.80	±0.10	±0.10	5.0%		(I)
	C1608X7R152KDTS	C1608X7R152KDT	1V, 1kHz	1.5	nF	±10%	0.80	±0.10	±0.10	5.0%		(I)
	C1608X7R182KDTS	C1608X7R182KDT	1V, 1kHz	1.8	nF	±10%	0.80	±0.10	±0.10	5.0%		(I)
	C1608X7R222KDTS	C1608X7R222KDT	1V, 1kHz	2.2	nF	±10%	0.80	±0.10	±0.10	5.0%		(I)
	C1608X7R272KDTS	C1608X7R272KDT	1V, 1kHz	2.7	nF	±10%	0.80	±0.10	±0.10	5.0%		(I)
	C1608X7R332KDTS	C1608X7R332KDT	1V, 1kHz	3.3	nF	±10%	0.80	±0.10	±0.10	5.0%		(I)
	C1608X7R392KDTS	C1608X7R392KDT	1V, 1kHz	3.9	nF	±10%	0.80	±0.10	±0.10	5.0%		(I)
	C1608X7R472KDTS	C1608X7R472KDT	1V, 1kHz	4.7	nF	±10%	0.80	±0.10	±0.10	5.0%		(I)
	C1608X7R562KDTS	C1608X7R562KDT	1V, 1kHz	5.6	nF	±10%	0.80	±0.10	±0.10	5.0%		(I)
	C1608X7R682KDTS	C1608X7R682KDT	1V, 1kHz	6.8	nF	±10%	0.80	±0.10	±0.10	5.0%		(I)
	C1608X7R822KDTS	C1608X7R822KDT	1V, 1kHz	8.2	nF	±10%	0.80	±0.10	±0.10	5.0%		(I)
	C1608X7R103KDTS	C1608X7R103KDT	1V, 1kHz	10	nF	±10%	0.80	±0.10	±0.10	5.0%		(I)
	C1608X7R123KDTS	C1608X7R123KDT	1V, 1kHz	12	nF	±10%	0.80	±0.10	±0.10	5.0%		(I)
	C1608X7R153KDTS	C1608X7R153KDT	1V, 1kHz	15	nF	±10%	0.80	±0.10	±0.10	5.0%		(I)
	C1608X7R183KDTS	C1608X7R183KDT	1V, 1kHz	18	nF	±10%	0.80	±0.10	±0.10	5.0%		(I)
	C1608X7R223KDTS	C1608X7R223KDT	1V, 1kHz	22	nF	±10%	0.80	±0.10	±0.10	5.0%		(I)
	C1608X7R273KDTS	C1608X7R273KDT	1V, 1kHz	27	nF	±10%	0.80	±0.10	±0.10	5.0%		(I)
	C1608X7R333KDTS	C1608X7R333KDT	1V, 1kHz	33	nF	±10%	0.80	±0.10	±0.10	5.0%		(I)
	C1608X7R393KDTS	C1608X7R393KDT	1V, 1kHz	39	nF	±10%	0.80	±0.10	±0.10	5.0%		(I)
	C1608X7R473KDTS	C1608X7R473KDT	1V, 1kHz	47	nF	±10%	0.80	±0.10	±0.10	5.0%		(I)
C1608X7R563KDTS	C1608X7R563KDT	1V, 1kHz	56	nF	±10%	0.80	±0.10	±0.10	5.0%	(I)		
C1608X7R683KDTS	C1608X7R683KDT	1V, 1kHz	68	nF	±10%	0.80	±0.10	±0.10	5.0%	(I)		
C1608X7R823KDTS	C1608X7R823KDT	1V, 1kHz	82	nF	±10%	0.80	±0.10	±0.10	5.0%	(I)		
C1608X7R104KDTS	C1608X7R104KDT	1V, 1kHz	100	nF	±10%	0.80	±0.10	±0.10	5.0%	(I)		
C1608X7R124KDTS	C1608X7R124KDT	1V, 1kHz	120	nF	±10%	0.80	±0.10	±0.10	5.0%	(I)		
C1608X7R154KDTS	C1608X7R154KDT	1V, 1kHz	150	nF	±10%	0.80	±0.10	±0.10	5.0%	(I)		
C1608X7R224KDTS	C1608X7R224KDT	1V, 1kHz	220	nF	±10%	0.80	±0.15	±0.15	5.0%	(I)		
C1608X7R334KDTS	C1608X7R334KDT	1V, 1kHz	330	nF	±10%	0.80	±0.15	±0.15	10.0%	(I)		
C1608X7R474KDTS	C1608X7R474KDT	1V, 1kHz	470	nF	±10%	0.80	±0.15	±0.15	10.0%	(I)		
C1608X7R684KDTS	C1608X7R684KDT	1V, 1kHz	680	nF	±10%	0.80	±0.15	±0.15	10.0%	(I)		
C1608X7R105□DTS	C1608X7R105□DT	1V, 1kHz	1.0	uF	±10%, ±20%	0.80	±0.15	±0.15	10.0%	(II)		
C1608X7R225KDTS	C1608X7R225KDT	1V, 1kHz	2.2	uF	±10%	0.80	±0.15	±0.15	10.0%	(II)		
C1608X7R475KDTS	C1608X7R475KDT	1V, 1kHz	4.7	uF	±10%	0.80	±0.20	±0.20	10.0%	(II)*		
6.3V	C1608X7R223KCTS	C1608X7R223KCT	1V, 1kHz	22	nF	±10%	0.80	±0.10	±0.10	5.0%	Paper, 4Kpcs	(I)
	C1608X7R104KCTS	C1608X7R104KCT	1V, 1kHz	100	nF	±10%	0.80	±0.10	±0.10	5.0%		(I)
	C1608X7R474KCTS	C1608X7R474KCT	1V, 1kHz	470	nF	±10%	0.80	±0.15	±0.15	10.0%		(I)
	C1608X7R105KCTS	C1608X7R105KCT	1V, 1kHz	1.0	uF	±10%	0.80	±0.15	±0.15	10.0%		(II)
	C1608X7R225KCTS	C1608X7R225KCT	1V, 1kHz	2.2	uF	±10%	0.80	±0.15	±0.15	10.0%		(II)
	C1608X7R475□CTS	C1608X7R475□CT	1V, 1kHz	4.7	uF	±10%, ±20%	0.80	±0.20	±0.20	10.0%		(II)

□ Tolerance Code: J=±5%, K=±10%, M=±20%; Special tolerance on the request.

(II)* High temperature load life test are applicable in rated voltage *100%. (II)/(II)* are applied with derating voltage.

● C2012X7R Series (EIA0805)

RV	DARFON P/N	DARFON P/N 2	Measuring Condition	Capacitance		Available Tolerance	Thick. (mm)	Tolerance(mm)		DF (max.)	Standard Packing	Test Spec.	
				Value	Unit			L/W	Thick.				
50V	C2012X7R101KGTS	C2012X7R101KGT	1V, 1kHz	100	pF	±10%	0.85	±0.15	±0.15	2.5%	Paper, 4Kpcs	(I)	
	C2012X7R151KGTS	C2012X7R151KGT	1V, 1kHz	150	pF	±10%	0.85	±0.15	±0.15	2.5%		(I)	
	C2012X7R181KGTS	C2012X7R181KGT	1V, 1kHz	180	pF	±10%	0.85	±0.15	±0.15	2.5%		(I)	
	C2012X7R221KGTS	C2012X7R221KGT	1V, 1kHz	220	pF	±10%	0.85	±0.15	±0.15	2.5%		(I)	
	C2012X7R271KGTS	C2012X7R271KGT	1V, 1kHz	270	pF	±10%	0.85	±0.15	±0.15	2.5%		(I)	
	C2012X7R331KGTS	C2012X7R331KGT	1V, 1kHz	330	pF	±10%	0.85	±0.15	±0.15	2.5%		(I)	
	C2012X7R391KGTS	C2012X7R391KGT	1V, 1kHz	390	pF	±10%	0.85	±0.15	±0.15	2.5%		(I)	
	C2012X7R471KGTS	C2012X7R471KGT	1V, 1kHz	470	pF	±10%	0.85	±0.15	±0.15	2.5%		(I)	
	C2012X7R561KGTS	C2012X7R561KGT	1V, 1kHz	560	pF	±10%	0.85	±0.15	±0.15	2.5%		(I)	
	C2012X7R681KGTS	C2012X7R681KGT	1V, 1kHz	680	pF	±10%	0.85	±0.15	±0.15	2.5%		(I)	
	C2012X7R821KGTS	C2012X7R821KGT	1V, 1kHz	820	pF	±10%	0.85	±0.15	±0.15	2.5%		(I)	
	C2012X7R102□GTS	C2012X7R102□GT	1V, 1kHz	1.0	nF	±5%, ±10%	0.85	±0.15	±0.15	2.5%		(I)	
	C2012X7R122KGTS	C2012X7R122KGT	1V, 1kHz	1.2	nF	±10%	0.85	±0.15	±0.15	2.5%		(I)	
	C2012X7R152KGTS	C2012X7R152KGT	1V, 1kHz	1.5	nF	±10%	0.85	±0.15	±0.15	2.5%		(I)	
	C2012X7R182KGTS	C2012X7R182KGT	1V, 1kHz	1.8	nF	±10%	0.85	±0.15	±0.15	2.5%		(I)	
	C2012X7R222KGTS	C2012X7R222KGT	1V, 1kHz	2.2	nF	±10%	0.85	±0.15	±0.15	2.5%		(I)	
	C2012X7R272KGTS	C2012X7R272KGT	1V, 1kHz	2.7	nF	±10%	0.85	±0.15	±0.15	2.5%		(I)	
	C2012X7R332KGTS	C2012X7R332KGT	1V, 1kHz	3.3	nF	±10%	0.85	±0.15	±0.15	2.5%		(I)	
	C2012X7R392KGTS	C2012X7R392KGT	1V, 1kHz	3.9	nF	±10%	0.85	±0.15	±0.15	2.5%		(I)	
	C2012X7R472KGTS	C2012X7R472KGT	1V, 1kHz	4.7	nF	±10%	0.85	±0.15	±0.15	2.5%		(I)	
	C2012X7R562KGTS	C2012X7R562KGT	1V, 1kHz	5.6	nF	±10%	0.85	±0.15	±0.15	2.5%		(I)	
	C2012X7R682KGTS	C2012X7R682KGT	1V, 1kHz	6.8	nF	±10%	0.85	±0.15	±0.15	2.5%		(I)	
	C2012X7R82KGPSG		1V, 1kHz	6.8	nF	±10%	1.25	±0.15	±0.20	2.5%		Embossed, 3Kpcs	(I)
	C2012X7R822KGTS	C2012X7R822KGT	1V, 1kHz	8.2	nF	±10%	0.85	±0.15	±0.15	2.5%		Paper, 4Kpcs	(I)
	C2012X7R103□GTS	C2012X7R103□GT	1V, 1kHz	10	nF	±5%, ±10%	0.85	±0.15	±0.15	2.5%			(I)
	C2012X7R123KGTS	C2012X7R123KGT	1V, 1kHz	12	nF	±10%	0.85	±0.15	±0.15	2.5%	(I)		
	C2012X7R153KGTS	C2012X7R153KGT	1V, 1kHz	15	nF	±10%	0.85	±0.15	±0.15	2.5%	(I)		
	C2012X7R183KGTS	C2012X7R183KGT	1V, 1kHz	18	nF	±10%	0.85	±0.15	±0.15	2.5%	(I)		
	C2012X7R223□GTS	C2012X7R223□GT	1V, 1kHz	22	nF	±5%, ±10%	0.85	±0.15	±0.15	2.5%	(I)		
	C2012X7R273KGTS	C2012X7R273KGT	1V, 1kHz	27	nF	±10%	0.85	±0.15	±0.15	2.5%	(I)		
	C2012X7R333KGTS	C2012X7R333KGT	1V, 1kHz	33	nF	±10%	0.85	±0.15	±0.15	2.5%	(I)		
	C2012X7R393KGTS	C2012X7R393KGT	1V, 1kHz	39	nF	±10%	0.85	±0.15	±0.15	2.5%	(I)		
	C2012X7R473KGTS	C2012X7R473KGT	1V, 1kHz	47	nF	±10%	0.85	±0.15	±0.15	2.5%	(I)		
	C2012X7R563KGTS	C2012X7R563KGT	1V, 1kHz	56	nF	±10%	0.85	±0.15	±0.15	2.5%	(I)		
	C2012X7R683KGTS	C2012X7R683KGT	1V, 1kHz	68	nF	±10%	0.85	±0.15	±0.15	2.5%	(I)		
	C2012X7R823KGTS	C2012X7R823KGT	1V, 1kHz	82	nF	±10%	0.85	±0.15	±0.15	2.5%	(I)		
	C2012X7R104□GTSD		1V, 1kHz	100	nF	±5%, ±10%, ±20%	0.80	±0.15	±0.10	2.5%	(I)		
	C2012X7R104KGTS	C2012X7R104KGT	1V, 1kHz	100	nF	±10%	0.85	±0.15	±0.15	2.5%	(I)		
	C2012X7R124KGTS	C2012X7R124KGT	1V, 1kHz	120	nF	±10%	0.85	±0.15	±0.15	2.5%	(I)		
	C2012X7R154KGTS	C2012X7R154KGT	1V, 1kHz	150	nF	±10%	0.85	±0.15	±0.15	2.5%	(I)		
	C2012X7R184KGTS	C2012X7R184KGT	1V, 1kHz	180	nF	±10%	0.85	±0.15	±0.15	3.0%	(I)		
	C2012X7R184KGPSG		1V, 1kHz	180	nF	±10%	1.25	±0.15	±0.20	3.0%	Embossed, 3Kpcs		(I)
	C2012X7R224KGTS	C2012X7R224KGT	1V, 1kHz	220	nF	±10%	0.85	±0.15	±0.15	3.0%	Paper, 4Kpcs		(I)
	C2012X7R224KGPS	C2012X7R224KGP	1V, 1kHz	220	nF	±10%	1.25	±0.15	±0.20	3.0%	Embossed, 3Kpcs		(I)
	C2012X7R334KGPS	C2012X7R334KGP	1V, 1kHz	330	nF	±10%	1.25	±0.15	±0.20	3.0%			(I)
C2012X7R474KGPS	C2012X7R474KGP	1V, 1kHz	470	nF	±10%	1.25	±0.15	±0.20	3.5%	(I)			
C2012X7R684KGPS	C2012X7R684KGP	1V, 1kHz	680	nF	±10%	1.25	±0.15/±0.20	±0.20	10.0%	(II)			
C2012X7R105□GPSG	C2012X7R105□GP	1V, 1kHz	1.0	uF	±10%, ±20%	1.25	±0.15/±0.20	±0.20	10.0%	(II)			
C2012X7R225KGPSG	C2012X7R225KGP	1V, 1kHz	2.2	uF	±10%	1.25	±0.20	±0.20	10.0%	(II)			

RV	DARFON P/N	DARFON P/N 2	Measuring Condition	Capacitance		Available Tolerance	Thick. (mm)	Tolerance(mm)		DF (max.)	Standard Packing	Test Spec.
				Value	Unit			L/W	Thick.			
35V	C2012X7R474KNPS	C2012X7R474KNP	1V, 1kHz	470	nF	±10%	1.25	±0.15	±0.20	3.5%	Embossed, 3Kpcs	(I)
	C2012X7R102KFST	C2012X7R102KFT	1V, 1kHz	1.0	nF	±10%	0.85	±0.15	±0.15	3.5%		(I)
	C2012X7R122KFST	C2012X7R122KFT	1V, 1kHz	1.2	nF	±10%	0.85	±0.15	±0.15	3.5%		(I)
	C2012X7R152KFST	C2012X7R152KFT	1V, 1kHz	1.5	nF	±10%	0.85	±0.15	±0.15	3.5%		(I)
	C2012X7R182KFST	C2012X7R182KFT	1V, 1kHz	1.8	nF	±10%	0.85	±0.15	±0.15	3.5%		(I)
	C2012X7R222KFST	C2012X7R222KFT	1V, 1kHz	2.2	nF	±10%	0.85	±0.15	±0.15	3.5%		(I)
	C2012X7R272KFST	C2012X7R272KFT	1V, 1kHz	2.7	nF	±10%	0.85	±0.15	±0.15	3.5%		(I)
	C2012X7R332KFST	C2012X7R332KFT	1V, 1kHz	3.3	nF	±10%	0.85	±0.15	±0.15	3.5%		(I)
	C2012X7R392KFST	C2012X7R392KFT	1V, 1kHz	3.9	nF	±10%	0.85	±0.15	±0.15	3.5%		(I)
	C2012X7R472KFST	C2012X7R472KFT	1V, 1kHz	4.7	nF	±10%	0.85	±0.15	±0.15	3.5%		(I)
	C2012X7R562KFST	C2012X7R562KFT	1V, 1kHz	5.6	nF	±10%	0.85	±0.15	±0.15	3.5%		(I)
	C2012X7R682KFST	C2012X7R682KFT	1V, 1kHz	6.8	nF	±10%	0.85	±0.15	±0.15	3.5%		(I)
	C2012X7R103KFST	C2012X7R103KFT	1V, 1kHz	10	nF	±10%	0.85	±0.15	±0.15	3.5%		(I)
	C2012X7R123KFST	C2012X7R123KFT	1V, 1kHz	12	nF	±10%	0.85	±0.15	±0.15	3.5%		(I)
	C2012X7R153KFST	C2012X7R153KFT	1V, 1kHz	15	nF	±10%	0.85	±0.15	±0.15	3.5%		(I)
	C2012X7R183KFST	C2012X7R183KFT	1V, 1kHz	18	nF	±10%	0.85	±0.15	±0.15	3.5%		(I)
	C2012X7R223KFST	C2012X7R223KFT	1V, 1kHz	22	nF	±10%	0.85	±0.15	±0.15	3.5%		(I)
	C2012X7R273KFST	C2012X7R273KFT	1V, 1kHz	27	nF	±10%	0.85	±0.15	±0.15	3.5%		(I)
	C2012X7R333KFST	C2012X7R333KFT	1V, 1kHz	33	nF	±10%	0.85	±0.15	±0.15	3.5%		(I)
	C2012X7R393KFST	C2012X7R393KFT	1V, 1kHz	39	nF	±10%	0.85	±0.15	±0.15	3.5%		(I)
	C2012X7R473KFST	C2012X7R473KFT	1V, 1kHz	47	nF	±10%	0.85	±0.15	±0.15	3.5%		(I)
	C2012X7R563KFST	C2012X7R563KFT	1V, 1kHz	56	nF	±10%	0.85	±0.15	±0.15	3.5%		(I)
	C2012X7R683KFST	C2012X7R683KFT	1V, 1kHz	68	nF	±10%	0.85	±0.15	±0.15	3.5%		(I)
	C2012X7R823KFST	C2012X7R823KFT	1V, 1kHz	82	nF	±10%	0.85	±0.15	±0.15	3.5%		(I)
	C2012X7R104□FST	C2012X7R104□FT	1V, 1kHz	100	nF	±5%, ±10%	0.85	±0.15	±0.15	3.5%		(I)
	C2012X7R124KFST	C2012X7R124KFT	1V, 1kHz	120	nF	±10%	0.85	±0.15	±0.15	3.5%		(I)
	C2012X7R154KFST	C2012X7R154KFT	1V, 1kHz	150	nF	±10%	0.85	±0.15	±0.15	3.5%		(I)
	C2012X7R184KFST	C2012X7R184KFT	1V, 1kHz	180	nF	±10%	0.85	±0.15	±0.20	3.5%		(I)
	C2012X7R224KFST	C2012X7R224KFT	1V, 1kHz	220	nF	±10%	0.85	±0.15	±0.15	3.5%		(I)
	C2012X7R224KFPS	C2012X7R224KFP	1V, 1kHz	220	nF	±10%	1.25	±0.15	±0.20	3.5%		(I)
	C2012X7R334KFPS	C2012X7R334KFP	1V, 1kHz	330	nF	±10%	1.25	±0.15	±0.20	5.0%		(I)
	C2012X7R474KFPS	C2012X7R474KFP	1V, 1kHz	470	nF	±10%	1.25	±0.15/±0.20	±0.20	5.0%		(I)
C2012X7R684KFPS	C2012X7R684KFP	1V, 1kHz	680	nF	±10%	1.25	±0.15/±0.20	±0.20	5.0%	(I)		
C2012X7R105□FPS	C2012X7R105□FP	1V, 1kHz	1.0	uF	±10%, ±20%	1.25	±0.15/±0.20	±0.20	10.0%	(II)		
C2012X7R225KFPS	C2012X7R225KFP	1V, 1kHz	2.2	uF	±10%	1.25	±0.15/±0.20	±0.20	10.0%	(II)		
C2012X7R335KFPS	C2012X7R335KFP	1V, 1kHz	3.3	uF	±10%	1.25	±0.15/±0.20	±0.20	12.5%	(III)*		
C2012X7R475KFPS	C2012X7R475KFP	1V, 1kHz	4.7	uF	±10%	1.25	±0.15/±0.20	±0.20	12.5%	(III)*		
C2012X7R106KFPS	C2012X7R106KFP	1V, 1kHz	10	uF	±10%	1.25	±0.20	±0.20	12.5%	(III)*		
16V	C2012X7R123KETS	C2012X7R123KET	1V, 1kHz	12	nF	±10%	0.85	±0.15	±0.15	3.5%	Paper, 4Kpcs	(I)
	C2012X7R473KETS	C2012X7R473KET	1V, 1kHz	47	nF	±10%	0.85	±0.15	±0.15	3.5%		(I)
	C2012X7R104KETS	C2012X7R104KET	1V, 1kHz	100	nF	±10%	0.85	±0.15	±0.15	3.5%		(I)
	C2012X7R224KETS	C2012X7R224KET	1V, 1kHz	220	nF	±10%	0.85	±0.15	±0.15	3.5%		(I)
	C2012X7R224KEPS	C2012X7R224KEP	1V, 1kHz	220	nF	±10%	1.25	±0.15	±0.20	3.5%		(I)
	C2012X7R334KEPS	C2012X7R334KEP	1V, 1kHz	330	nF	±10%	1.25	±0.15	±0.20	5.0%		(I)
	C2012X7R474KEPS	C2012X7R474KEP	1V, 1kHz	470	nF	±10%	1.25	±0.15/±0.20	±0.20	5.0%		(I)
	C2012X7R684KEPS	C2012X7R684KEP	1V, 1kHz	680	nF	±10%	1.25	±0.15/±0.20	±0.20	5.0%		(I)
	C2012X7R105□EPS	C2012X7R105□EP	1V, 1kHz	1.0	uF	±10%, ±20%	1.25	±0.15/±0.20	±0.20	5.0%		(I)
	C2012X7R225□EPS	C2012X7R225□EP	1V, 1kHz	2.2	uF	±10%, ±20%	1.25	±0.15/±0.20	±0.20	10.0%		(II)
	C2012X7R335KEPS	C2012X7R335KEP	1V, 1kHz	3.3	uF	±10%	1.25	±0.15/±0.20	±0.20	10.0%		(II)
	C2012X7R475□EPS	C2012X7R475□EP	1V, 1kHz	4.7	uF	±10%, ±20%	1.25	±0.15/±0.20	±0.20	10.0%		(II)
	C2012X7R106□EPS	C2012X7R106□EP	1V, 1kHz	10	uF	±10%, ±20%	1.25	±0.15/±0.20	±0.20	10.0%		(III)*
	C2012X7R105□DPS	C2012X7R105□DP	1V, 1kHz	1.0	uF	±10%, ±20%	1.25	±0.15/±0.20	±0.20	5.0%		(I)
	C2012X7R225□DPS	C2012X7R225□DP	1V, 1kHz	2.2	uF	±10%, ±20%	1.25	±0.15/±0.20	±0.20	10.0%		(II)
	10V	C2012X7R335KDPS	C2012X7R335KDP	1V, 1kHz	3.3	uF	±10%	1.25	±0.15/±0.20	±0.20		10.0%
C2012X7R475KDPS		C2012X7R475KDP	1V, 1kHz	4.7	uF	±10%	1.25	±0.15/±0.20	±0.20	10.0%	(II)	
C2012X7R106KDPS		C2012X7R106KDP	1V, 1kHz	10	uF	±10%	1.25	±0.15/±0.20	±0.20	10.0%	(II)	
C2012X7R226MDPS		C2012X7R226MDP	0.5V, 120Hz	22	uF	±20%	1.25	±0.20	±0.20	10.0%	(III)*	
C2012X7R335KCPS		C2012X7R335KCP	1V, 1kHz	3.3	uF	±10%	1.25	±0.15/±0.20	±0.20	10.0%	(II)	
C2012X7R475KCPS		C2012X7R475KCP	1V, 1kHz	4.7	uF	±10%	1.25	±0.15/±0.20	±0.20	10.0%	(II)	
6.3V	C2012X7R106□CPS	C2012X7R106□CP	1V, 1kHz	10	uF	±10%, ±20%	1.25	±0.15/±0.20	±0.20	15.0%	Embossed, 3Kpcs	(II)
	C2012X7R226MCPS	C2012X7R226MCP	0.5V, 120Hz	22	uF	±20%	1.25	±0.20	±0.20	10.0%		(III)*
	C2012X7R106□BPS	C2012X7R106□BP	1V, 1kHz	10	uF	±10%, ±20%	1.25	±0.15/±0.20	±0.20	15.0%		Embossed, 3Kpcs

□ Tolerance Code: K=±10%, M=±20% ;Special tolerance on the request.

(II)* High temperature load life test are applicable in rated voltage *100%. (II)/(II)* are applied with derating voltage.

● C3216X7R Series (EIA1206)

RV	DARFON P/N	DARFON P/N 2	Measuring Condition	Capacitance		Available Tolerance	Thick. (mm)	Tolerance(mm)		DF (max.)	Standard Packing	Test Spec.
				Value	Unit			L/W	Thick.			
50V	C3216X7R221KGTS	C3216X7R221KGT	1V, 1kHz	220	pF	±10%	0.85	±0.15	±0.10	3.5%	Paper, 4Kpcs	(I)
	C3216X7R102KGTS	C3216X7R102KGT	1V, 1kHz	1.0	nF	±10%	0.85	±0.15	±0.10	3.5%		(I)
	C3216X7R182KGTS	C3216X7R182KGT	1V, 1kHz	1.8	nF	±10%	0.85	±0.15	±0.10	3.5%		(I)
	C3216X7R222KGTS	C3216X7R222KGT	1V, 1kHz	2.2	nF	±10%	0.85	±0.15	±0.10	3.5%		(I)
	C3216X7R472KGTS	C3216X7R472KGT	1V, 1kHz	4.7	nF	±10%	0.85	±0.15	±0.10	3.5%		(I)
	C3216X7R562□GTS	C3216X7R562□GT	1V, 1kHz	5.6	nF	±5%, ±10%	0.85	±0.15	±0.10	3.5%		(I)
	C3216X7R103□GTS	C3216X7R103□GT	1V, 1kHz	10	nF	±10%, ±20%	0.85	±0.15	±0.10	3.5%		(I)
	C3216X7R123KGTS	C3216X7R123KGT	1V, 1kHz	12	nF	±10%	0.85	±0.15	±0.10	3.5%		(I)
	C3216X7R153KGTS	C3216X7R153KGT	1V, 1kHz	15	nF	±10%	0.85	±0.15	±0.10	3.5%		(I)
	C3216X7R183KGTS	C3216X7R183KGT	1V, 1kHz	18	nF	±10%	0.85	±0.15	±0.10	3.5%		(I)
	C3216X7R223KGTS	C3216X7R223KGT	1V, 1kHz	22	nF	±10%	0.85	±0.15	±0.10	3.5%		(I)
	C3216X7R273KGTS	C3216X7R273KGT	1V, 1kHz	27	nF	±10%	0.85	±0.15	±0.10	3.5%		(I)
	C3216X7R333KGTS	C3216X7R333KGT	1V, 1kHz	33	nF	±10%	0.85	±0.15	±0.10	3.5%		(I)
	C3216X7R393KGTS	C3216X7R393KGT	1V, 1kHz	39	nF	±10%	0.85	±0.15	±0.10	3.5%		(I)
	C3216X7R473KGTS	C3216X7R473KGT	1V, 1kHz	47	nF	±10%	0.85	±0.15	±0.10	3.5%		(I)
	C3216X7R563KGTS	C3216X7R563KGT	1V, 1kHz	56	nF	±10%	0.85	±0.15	±0.10	3.5%		(I)
	C3216X7R683KGTS	C3216X7R683KGT	1V, 1kHz	68	nF	±10%	0.85	±0.15	±0.10	3.5%		(I)
	C3216X7R823KGTS	C3216X7R823KGT	1V, 1kHz	82	nF	±10%	0.85	±0.15	±0.10	3.5%		(I)
	C3216X7R104□GTS	C3216X7R104□GT	1V, 1kHz	100	nF	±5%, ±10%	0.85	±0.15	±0.10	3.5%		(I)
	C3216X7R224KGPS	C3216X7R224KGP	1V, 1kHz	220	nF	±10%	0.95	±0.15	±0.10	3.5%		(I)
	C3216X7R224KGPSF		1V, 1kHz	220	nF	±10%	1.15	±0.20	±0.10	3.5%		(I)
	C3216X7R334□GPS	C3216X7R334□GP	1V, 1kHz	330	nF	±5%, ±10%	1.25	±0.15	±0.15	3.5%		(I)
	C3216X7R474KGPSG		1V, 1kHz	470	nF	±10%	1.25	±0.15	±0.15	3.5%		(I)
	C3216X7R474KGPS	C3216X7R474KGP	1V, 1kHz	470	nF	±10%	1.60	±0.15	±0.20	3.5%		(I)
	C3216X7R684KGPS	C3216X7R684KGP	1V, 1kHz	680	nF	±10%	1.60	+0.3/-0.1	+0.3/-0.1	3.5%		(I)
	C3216X7R105KGPSG		1V, 1kHz	1.0	uF	±10%	1.25	±0.15	±0.15	3.5%		(I)
	C3216X7R105KGPS	C3216X7R105KGP	1V, 1kHz	1.0	uF	±10%	1.60	±0.30	±0.30	3.5%		(I)
	C3216X7R225KGPSL	C3216X7R225KGP	1V, 1kHz	2.2	uF	±10%	1.60	±0.20	±0.20	10.0%		(II)
C3216X7R475KGPS	C3216X7R475KGP	1V, 1kHz	4.7	uF	±10%	1.60	±0.30	±0.30	10.0%	(II)		
C3216X7R106KGPSL	C3216X7R106KGP	1V, 1kHz	10	uF	±10%	1.60	±0.20	±0.20	10.0%	(II)		
35V	C3216X7R105MNP	C3216X7R105MNP	1V, 1kHz	1.0	uF	±20%	1.60	±0.30	±0.30	3.5%	(I)	
	C3216X7R106KNP	C3216X7R106KNP	1V, 1kHz	10	uF	±10%	1.60	±0.20	±0.20	10.0%	(II)	
25V	C3216X7R224KFPS	C3216X7R224KFP	1V, 1kHz	220	nF	±10%	0.95	±0.15	±0.10	3.5%	Embossed, 3Kpcs	(I)
	C3216X7R334KFPS	C3216X7R334KFP	1V, 1kHz	330	nF	±10%	0.95	±0.15	±0.10	3.5%	Embossed, 3Kpcs	(I)
	C3216X7R334KFPSG		1V, 1kHz	330	nF	±10%	1.25	±0.15	±0.20	3.5%	Embossed, 3Kpcs	(I)
	C3216X7R474KFPS	C3216X7R474KFP	1V, 1kHz	470	nF	±10%	1.25	±0.15	±0.20	3.5%	Embossed, 3Kpcs	(I)
	C3216X7R474KFPSL		1V, 1kHz	470	nF	±10%	1.60	±0.30	±0.30	3.5%	Embossed, 2Kpcs	(I)
	C3216X7R105□FPSG		1V, 1kHz	1.0	uF	±10%, ±20%	1.25	±0.15	±0.20	3.5%	Embossed, 3Kpcs	(I)
	C3216X7R105KFPS	C3216X7R105KFP	1V, 1kHz	1.0	uF	±10%	1.60	±0.30	±0.30	3.5%	Embossed, 2Kpcs	(I)
	C3216X7R225KFPS	C3216X7R225KFP	1V, 1kHz	2.2	uF	±10%	1.60	±0.30	±0.30	5.0%	(I)	
	C3216X7R475KFPS	C3216X7R475KFP	1V, 1kHz	4.7	uF	±10%	1.60	±0.30	±0.30	10.0%	Embossed, 2Kpcs	(II)
C3216X7R106□FPS	C3216X7R106□FP	1V, 1kHz	10	uF	±10%, ±20%	1.60	±0.30	±0.30	10.0%	(III)*	(II)*	
16V	C3216X7R104KETS	C3216X7R104KET	1V, 1kHz	100	nF	±10%	0.85	±0.15	±0.10	3.5%	Paper, 4Kpcs	(I)
	C3216X7R474KEPS	C3216X7R474KEP	1V, 1kHz	470	nF	±10%	1.25	±0.15	±0.20	5.0%	Embossed, 3Kpcs	(I)
	C3216X7R474KEPSL		1V, 1kHz	470	nF	±10%	1.60	±0.30	±0.30	5.0%	Embossed, 2Kpcs	(I)
	C3216X7R105KEPSL		1V, 1kHz	1.0	uF	±10%	1.60	±0.30	±0.30	5.0%	(I)	
	C3216X7R225KEPS	C3216X7R225KEP	1V, 1kHz	2.2	uF	±10%	1.60	±0.30	±0.30	10.0%	(I)	
	C3216X7R475□EPS	C3216X7R475□EP	1V, 1kHz	4.7	uF	±10%, ±20%	1.60	±0.30	±0.30	10.0%	Embossed, 2Kpcs	(II)
C3216X7R106□EPS	C3216X7R106□EP	1V, 1kHz	10	uF	±10%, ±20%	1.60	±0.30	±0.30	10.0%	(III)*	(II)*	
C3216X7R226□EPS	C3216X7R226□EP	0.5V, 120Hz	22	uF	±10%, ±20%	1.60	±0.30	±0.30	10.0%	(III)*	(II)*	
10V	C3216X7R225KDPS	C3216X7R225KDP	1V, 1kHz	2.2	uF	±10%	1.60	±0.30	±0.30	10.0%	(I)	
	C3216X7R475□DPS	C3216X7R475□DP	1V, 1kHz	4.7	uF	±10%, ±20%	1.60	±0.30	±0.30	10.0%	(II)	
	C3216X7R106□DPS	C3216X7R106□DP	1V, 1kHz	10	uF	±10%, ±20%	1.60	±0.30	±0.30	10.0%	(II)	
	C3216X7R226□DPS	C3216X7R226□DP	0.5V, 120Hz	22	uF	±10%, ±20%	1.60	±0.30	±0.30	10.0%	(III)*	(II)*
6.3V	C3216X7R106KCPS	C3216X7R106KCP	1V, 1kHz	10	uF	±10%	1.60	±0.30	±0.30	10.0%	Embossed, 2Kpcs	(II)
	C3216X7R226KCPS	C3216X7R226KCP	0.5V, 120Hz	22	uF	±10%	1.60	±0.30	±0.30	10.0%		(II)

● C3225X7R Series (EIA1210)

RV	DARFON P/N	DARFON P/N 2	Measuring Condition	Capacitance		Available Tolerance	Thick. (mm)	Tolerance(mm)		DF (max.)	Standard Packing	Test Spec.
				Value	Unit			L/W	Thick.			
50V	C3225X7R225MGPS	C3225X7R225MGP	1V , 1kHz	2.2	uF	±20%	2.50	±0.3/±0.2	±0.20	5.0%	Embossed, 1Kpcs	(II)
	C3225X7R475KGPS	C3225X7R475KGP	1V , 1kHz	4.7	uF	±10%	2.50	±0.3/±0.2	±0.20	10.0%	Embossed, 1Kpcs	(II)
	C3225X7R106KGWS	C3225X7R106KGW	1V , 1kHz	10	uF	±10%	2.00	±0.3/±0.2	±0.20	15.0%	Embossed, 1Kpcs	(II)
	C3225X7R106□GPS	C3225X7R106□GP	1V , 1kHz	10	uF	±10%, ±20%	2.50	±0.30	±0.30	10.0%		(II)
35V	C3225X7R106KNPS	C3225X7R106KNP	1V , 1kHz	10	uF	±10%	2.50	±0.30	±0.30	10.0%	Embossed, 1Kpcs	(II)
25V	C3225X7R475KFPS	C3225X7R475KFP	1V , 1kHz	4.7	uF	±10%	2.00	±0.3/±0.2	±0.20	10.0%	Embossed, 2Kpcs	(I)
	C3225X7R475KFSP		1V , 1kHz	4.7	uF	±10%	2.50	±0.30	±0.30	10.0%	Embossed, 1Kpcs	(I)
	C3225X7R106KFPS	C3225X7R106KFP	1V , 1kHz	10	uF	±10%	2.00	±0.3/±0.2	±0.30	10.0%	Embossed, 2Kpcs	(II)
	C3225X7R226□FPS	C3225X7R226□FP	0.5V , 120Hz	22	uF	±10%, ±20%	2.50	±0.3/±0.2	±0.20	10.0%	Embossed, 1Kpcs	(II)
16V	C3225X7R475KEPS	C3225X7R475KEP	1V , 1kHz	4.7	uF	±10%	2.50	±0.3/±0.2	±0.20	5.0%	Embossed, 1Kpcs	(II)
	C3225X7R106KEPS	C3225X7R106KEP	1V , 1kHz	10	uF	±10%	2.00	±0.3/±0.2	±0.20	10.0%	Embossed, 2Kpcs	(II)
	C3225X7R226□EPS	C3225X7R226□EP	0.5V , 120Hz	22	uF	±10%, ±20%	2.50	±0.3/±0.2	±0.30	10.0%	Embossed, 1Kpcs	(II)
10V	C3225X7R226KDPS	C3225X7R226KDP	0.5V , 120Hz	22	uF	±10%	2.50	±0.3/±0.2	±0.20	10.0%		(II)
	C3225X7R476□DPS	C3225X7R476□DP	0.5V , 120Hz	47	uF	±10%, ±20%	2.50	±0.3/±0.2	±0.20	10.0%	Embossed, 1Kpcs	(II)
6.3V	C3225X7R476□CPS	C3225X7R476□CP	0.5V , 120Hz	47	uF	±10%, ±20%	2.50	±0.3/±0.2	±0.20	10.0%	Embossed, 1Kpcs	(II)

■ X7S Series

● C0603X7S Series (EIA0201)

RV	DARFON P/N	DARFON P/N 2	Measuring Condition	Capacitance		Available Tolerance	Thick. (mm)	Tolerance(mm)		DF (max.)	Standard Packing	Test Spec.
				Value	Unit			L/W	Thick.			
16V	C0603X7S104□ETS	C0603X7S104□ET	1V , 1kHz	100	nF	±10%,±20%	0.30	± 0.05	±0.05	10.0%	Paper, 15Kpcs	(II)*
	C0603X7S104KDTS	C0603X7S104KDT	1V , 1kHz	100	nF	±10%	0.30	± 0.05	±0.05	10.0%	Paper, 15Kpcs	(II)
10V	C0603X7S224KDTS	C0603X7S224KDT	1V , 1kHz	220	nF	±10%	0.30	± 0.05	±0.05	12.5%	Paper, 15Kpcs	(II)*
	C0603X7S104KCTS	C0603X7S104KCT	1V , 1kHz	100	nF	±10%	0.30	± 0.05	±0.05	10.0%	Paper, 15Kpcs	(II)
6.3V	C0603X7S224KCTS	C0603X7S224KCT	1V , 1kHz	220	nF	±10%	0.30	± 0.05	±0.05	12.5%	Paper, 15Kpcs	(II)*

● C1005X7S Series (EIA0402)

RV	DARFON P/N	DARFON P/N 2	Measuring Condition	Capacitance		Available Tolerance	Thick. (mm)	Tolerance(mm)		DF (max.)	Standard Packing	Test Spec.
				Value	Unit			L/W	Thick.			
10V	C1005X7S105KDTS	C1005X7S105KDT	1V , 1kHz	1.0	uF	±10%	0.50	± 0.10	±0.10	10.0%	Paper, 10Kpcs	(II)*
	C1005X7S225□DTS	C1005X7S225□DT	1V , 1kHz	2.2	uF	±10%,±20%	0.50	± 0.20	±0.20	10.0%	Paper, 10Kpcs	(II)*
6.3V	C1005X7S225KCTS	C1005X7S225KCT	1V , 1kHz	2.2	uF	±10%	0.50	± 0.20	±0.20	10.0%	Paper, 10Kpcs	(II)

● C1608X7S Series (EIA0603)

RV	DARFON P/N	DARFON P/N 2	Measuring Condition	Capacitance		Available Tolerance	Thick. (mm)	Tolerance(mm)		DF (max.)	Standard Packing	Test Spec.
				Value	Unit			L/W	Thick.			
25V	C1608X7S225KFTS	C1608X7S225KFT	1V , 1kHz	2.2	uF	±10%	0.80	±0.20	±0.20	10.0%	Paper, 4Kpcs	(II)*
16V	C1608X7S225KETs	C1608X7S225KET	1V , 1kHz	2.2	uF	±10%	0.80	± 0.20	±0.20	10.0%	Paper, 4Kpcs	(II)
	C1608X7S475KETs	C1608X7S475KET	1V , 1kHz	4.7	uF	±10%	0.80	± 0.20	±0.20	10.0%	Paper, 4Kpcs	(II)
10V	C1608X7S225KDTS	C1608X7S225KDT	1V , 1kHz	2.2	uF	±10%	0.80	±0.20	±0.20	10.0%	Paper, 4Kpcs	(II)
	C1608X7S475KDTS	C1608X7S475KDT	1V , 1kHz	4.7	uF	±10%	0.80	±0.20	±0.20	10.0%	Paper, 4Kpcs	(II)
	C1608X7S106MDTS	C1608X7S106MDT	1V , 1kHz	10	uF	±20%	0.80	±0.20	±0.20	10.0%	Paper, 4Kpcs	(II)*
6.3V	C1608X7S475KCTS	C1608X7S475KCT	1V , 1kHz	4.7	uF	±10%	0.80	±0.20	±0.20	10.0%	Paper, 4Kpcs	(II)
	C1608X7S106MCTS	C1608X7S106MCT	1V , 1kHz	10	uF	±20%	0.80	±0.20	±0.20	10.0%	Paper, 4Kpcs	(II)*

● C2012X7S Series (EIA0805)

RV	DARFON P/N	DARFON P/N 2	Measuring Condition	Capacitance		Available Tolerance	Thick. (mm)	Tolerance(mm)		DF (max.)	Standard Packing	Test Spec.
				Value	Unit			L/W	Thick.			
50V	C2012X7S475KGPS	C2012X7S475KGP	1V , 1kHz	4.7	uF	±10%	1.25	± 0.20	±0.20	10.0%	Embossed, 3Kpcs	(II)
25V	C2012X7S225KFPS	C2012X7S225KFP	1V , 1kHz	2.2	uF	±10%	1.25	± 0.15	±0.15	10.0%	Embossed, 3Kpcs	(II)
	C2012X7S475KFPS	C2012X7S475KFP	1V , 1kHz	4.7	uF	±10%	1.25	±0.15/±0.20	±0.20	12.5%	Embossed, 3Kpcs	(II)*
	C2012X7S106□FPS	C2012X7S106□FP	1V , 1kHz	10	uF	±10%,±20%	1.25	± 0.20	±0.20	10.0%	Embossed, 3Kpcs	(II)*
16V	C2012X7S106□EPS	C2012X7S106□EP	1V , 1kHz	10	uF	±10%, ±20%	1.25	±0.15/±0.20	±0.20	10.0%	Embossed, 3Kpcs	(II)*
10V	C2012X7S226MDPS	C2012X7S226MDP	0.5V , 120Hz	22	uF	±20%	1.25	±0.20	±0.20	10.0%	Embossed, 3Kpcs	(II)*
6.3V	C2012X7S226MCPS	C2012X7S226MCP	0.5V , 120Hz	22	uF	±20%	1.25	±0.20	±0.20	10.0%	Embossed, 3Kpcs	(II)*

● C3216X7S Series (EIA1206)

RV	DARFON P/N	DARFON P/N 2	Measuring Condition	Capacitance		Available Tolerance	Thick. (mm)	Tolerance(mm)		DF (max.)	Standard Packing	Test Spec.
				Value	Unit			L/W	Thick.			
6.3V	C3216X7S476MCPS	C3216X7S476MCP	0.5V , 120Hz	47	uF	±20%	1.60	±0.30	±0.30	10.0%	Embossed,2Kpcs	(II)

● C3225X7S Series (EIA1210)

RV	DARFON P/N	DARFON P/N 2	Measuring Condition	Capacitance		Available Tolerance	Thick. (mm)	Tolerance(mm)		DF (max.)	Standard Packing	Test Spec.
				Value	Unit			L/W	Thick.			
50V	C3225X7S106□GPS	C3225X7S106□GP	1V , 1kHz	10	uF	±10%,±20%	2.50	±0.30	±0.30	10.0%	Embossed,1Kpcs	(II)
6.3V	C3225X7S107MCPS	C3225X7S107MCP	0.5V , 120Hz	100	uF	±20%	2.50	± 0.30	±0.30	10.0%	Embossed,1Kpcs	(II)*

□ Tolerance Code: K=±10%, M=±20%; Special tolerance on the request.

(II)* High temperature load life test are applicable in rated voltage *100%. (II)/(II)* are applied with derating voltage.

■ X7T Series

● C1005X7T Series (EIA0402)

RV	DARFON P/N	DARFON P/N 2	Measuring Condition	Capacitance		Available Tolerance	Thick. (mm)	Tolerance(mm)		DF (max.)	Standard Packing	Test Spec.
				Value	Unit			L/W	Thick.			
6.3V	C1005X7T474KCTS	C1005X7T474KCT	1V , 1kHz	470	nF	±10%	0.50	±0.10	±0.10	10.0%	Paper, 10Kpcs	(II)

● C1608X7T Series (EIA0603)

RV	DARFON P/N	DARFON P/N 2	Measuring Condition	Capacitance		Available Tolerance	Thick. (mm)	Tolerance(mm)		DF (max.)	Standard Packing	Test Spec.
				Value	Unit			L/W	Thick.			
10V	C1608X7T225MDTS	C1608X7T225MDT	1V , 1kHz	2.2	uF	±20%	0.80	±0.20	±0.20	10.0%	Paper, 4Kpcs	(II)
6.3V	C1608X7T106MCTS	C1608X7T106MCT	1V , 1kHz	10	uF	±20%	0.80	± 0.20	±0.20	10.0%	Paper, 4Kpcs	(II)*

● C2012X7T Series (EIA0805)

RV	DARFON P/N	DARFON P/N 2	Measuring Condition	Capacitance		Available Tolerance	Thick. (mm)	Tolerance(mm)		DF (max.)	Standard Packing	Test Spec.
				Value	Unit			L/W	Thick.			
10V	C2012X7T226MDPS	C2012X7T226MDP	0.5V , 120Hz	22	uF	±20%	1.25	± 0.20	±0.20	10.0%	Embossed, 3Kpcs	(II)*
6.3V	C2012X7T226MCPS	C2012X7T226MCP	0.5V , 120Hz	22	uF	±20%	1.25	± 0.20	±0.20	10.0%	Embossed, 3Kpcs	(II)

● C3216X7T Series (EIA1206)

RV	DARFON P/N	DARFON P/N 2	Measuring Condition	Capacitance		Available Tolerance	Thick. (mm)	Tolerance(mm)		DF (max.)	Standard Packing	Test Spec.
				Value	Unit			L/W	Thick.			
10V	C3216X7T226□DPS	C3216X7T226□DP	0.5V , 120Hz	22	uF	±10%,±20%	1.6	±0.30	±0.30	10.0%	Embossed, 2Kpcs	(II)*

□ Tolerance Code: K=±10%, M=±20%; Special tolerance on the request.

(II)* High temperature load life test are applicable in rated voltage *100%. (II)/(II)* are applied with derating voltage.

- X7U Series
- C3216X7U Series (EIA1206)

RV	DARFON P/N	DARFON P/N 2	Measuring Condition	Capacitance		Available Tolerance	Thick. (mm)	Tolerance(mm)		DF (max.)	Standard Packing	Test Spec.
				Value	Unit			L/W	Thick.			
6.3V	C3216X7U476MCPS	C3216X7U476MCP	0.5V , 120Hz	47	uF	±20%	1.60	± 0.30	±0.30	15.0%	Embossed, 2Kpcs	(II)*
4V	C3216X7U107MBPS	C3216X7U107MBP	0.5V , 120Hz	100	uF	±20%	1.60	± 0.30	±0.30	15.0%	Embossed, 2Kpcs	(II)*

□ Tolerance Code: K=±10%, M=±20%; Special tolerance on the request.

(II)* High temperature load life test are applicable in rated voltage *100%. (II)/(II)* are applied with derating voltage.

- X8R Series
- C1608X8R Series (EIA0603)

RV	DARFON P/N	DARFON P/N 2	Measuring Condition	Capacitance		Available Tolerance	Thick. (mm)	Tolerance(mm)		DF (max.)	Standard Packing	Test Spec.
				Value	Unit			L/W	Thick.			
50V	C1608X8R104KGTS	C1608X8R104KGT	1V , 1kHz	100	nF	±10%	0..8	±0.15	±0.15	7.5%	Paper, 4Kpcs	(I)

- C2012X8R Series (EIA0805)

RV	DARFON P/N	DARFON P/N 2	Measuring Condition	Capacitance		Available Tolerance	Thick. (mm)	Tolerance(mm)		DF (max.)	Standard Packing	Test Spec.
				Value	Unit			L/W	Thick.			
50V	C2012X8R104KGPS	C2012X8R104KGP	1V , 1kHz	100	nF	±10%	1.25	±0.15	±0.15	5.0%	Embossed, 3Kpcs	(I)

□ Tolerance Code: K=±10%, M=±20%; Special tolerance on the request.

- Test Spec.
- General Purpose (I)

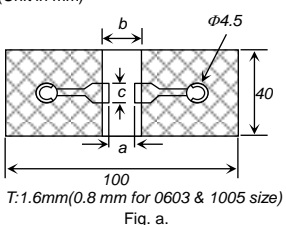
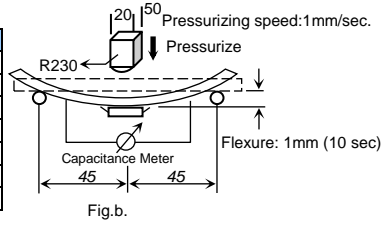
No	Item	Specification		Test Method																																
		Temp. compensation type	High dielectric constant type																																	
1	Operation Temperature Range	NP0: -55 to 125 °C	X5R: -55 to 85 °C X6S: -55 to 105 °C X7R/X7S/X7T/X7U : -55 to 125 °C X8R -55 to 150 °C	---																																
2	Rated Voltage	Shown in the table of "Part Number & Characteristic"		The rated voltage is defined as the maximum voltage, which may be applied continuously to the capacitor.																																
3	Appearance	No defects or abnormalities.		Visual inspection																																
4	Dimensions	Within the specified dimension.		Using calipers																																
5	Dielectric Strength	No defects or abnormalities.		No failure shall be observed when 250% of the rated voltage is applied between the terminations for 1 to 5 seconds. The charge and discharge current is less than 50mA.																																
6	Insulation Resistance (I.R.)	To apply rated voltage. I.R. $\geq 10G\Omega$ or $R_C C_R \geq 500\Omega \cdot F$ (whichever is smaller)		The insulation resistance shall be measured with a DC voltage not exceeding the rated voltage at 25 °C and 75%RH max, and within 1 minute of charging.																																
7	Capacitance	Within the specified tolerance * X5R, X6S, X7R, X7S, X7T, X7U and X8R at 1000 hours		The capacitance / D.F. shall be measured at 25 °C at the frequency and voltage shown in the table of "Part Number & Characteristic".																																
8	Q/Dissipation Factor (D.F.)	NP0: If $C \leq 30pF$, $DF \leq 1/(400+20C)$, C in pF If $C > 30pF$, $DF \leq 0.1\%$.	Shown in the table of "Part Number & Characteristic"																																	
9	Capacitance Temperature Characteristics	Capacitance change NP0 within $0 \pm 30ppm/^\circ C$ under operating temperature range.	Capacitance change X5R/X7R/X8R within $\pm 15\%$ X6S/X7S within $\pm 22\%$ X7T: -33% to + 22% X7U: -56% to + 22%	1. Temperature compensation type: The capacitance value at 25 °C and 85 °C shall be measured and calculated from the formula given below. $T.C. = (C_{85} - C_{25}) / C_{25} \cdot \Delta T \cdot 10^6 (PPM/^\circ C)$ 2. High dielectric constant type: The ranges of capacitance change compared with the 25 °C value over the temperature ranges shall be within the specified ranges. Measurement Voltage : Less than 1.0Vrms (Refer to the electrical characteristics)																																
10	Termination Strength	No removal of the terminations or marking defect.		Apply a parallel force of 5N to a PCB mounted sample for 10 ± 1 sec. *2N for 0603 (EIA 0201).																																
11	Deflection (Bending Strength)	No cracking or marking defects shall occur at 1mm deflection. Capacitance change: NP0: within $\pm 5\%$ or $\pm 0.5pF$. (whichever is larger) X5R, X6S, X7R, X7S, X7T, X7U, X8R within $\pm 12.5\%$		Solder the capacitor to the test jig (glass epoxy boards) shown in Fig.a using a SAC305(Sn96.5Ag3.0Cu0.5) solder (then let sit for 24 ± 2 hours for X5R, X6S, X7R, X7S, X7T, X7U and X8R). Then apply a force in the direction shown in Fig.b. The soldering shall be done with the reflow method and shall be conducted with care so that the soldering is uniform and free of defects such as heat shock.																																
		(Unit in mm) 	<table border="1"> <thead> <tr> <th>Size</th> <th>a</th> <th>b</th> <th>C</th> </tr> </thead> <tbody> <tr> <td>0603</td> <td>0.3</td> <td>0.9</td> <td>0.3</td> </tr> <tr> <td>1005</td> <td>0.4</td> <td>1.5</td> <td>0.5</td> </tr> <tr> <td>1608</td> <td>1.0</td> <td>3.0</td> <td>1.2</td> </tr> <tr> <td>2012</td> <td>1.2</td> <td>4.0</td> <td>1.65</td> </tr> <tr> <td>3216</td> <td>2.2</td> <td>5.0</td> <td>2.0</td> </tr> <tr> <td>4520</td> <td>3.5</td> <td>7.0</td> <td>2.5</td> </tr> <tr> <td>4532</td> <td>3.5</td> <td>7.0</td> <td>3.7</td> </tr> </tbody> </table>	Size	a	b	C	0603	0.3	0.9	0.3	1005	0.4	1.5	0.5	1608	1.0	3.0	1.2	2012	1.2	4.0	1.65	3216	2.2	5.0	2.0	4520	3.5	7.0	2.5	4532	3.5	7.0	3.7	
Size	a	b	C																																	
0603	0.3	0.9	0.3																																	
1005	0.4	1.5	0.5																																	
1608	1.0	3.0	1.2																																	
2012	1.2	4.0	1.65																																	
3216	2.2	5.0	2.0																																	
4520	3.5	7.0	2.5																																	
4532	3.5	7.0	3.7																																	
12	Solderability of Termination	90% of the terminations are to be soldered evenly and continuously.		Immerse the test capacitor into a methanol solution containing rosin for 3 to 5 seconds, preheat it 150 to 180 °C for 2 to 3 minutes and immerse it into SAC305(Sn96.5Ag3.0Cu0.5) solder of $245 \pm 5^\circ C$ for 3 ± 1 seconds.																																
13	Resistance to Soldering Heat	Appearance	No marking defects	*Preheat the capacitor at 120 to 150 °C for 1 minute.																																
		Cap. Change	NP0 within $\pm 2.5\%$ or 0.25pF (whichever is larger)	Immerse the capacitor in a SAC305(Sn96.5Ag3.0Cu0.5) solder solution at $270 \pm 5^\circ C$ for 10 ± 1 seconds. Let sit at room temperature for 24 ± 2 hours, then measure.																																
		Q/D.F.	If $C \leq 30pF$, $DF \leq 1/(400+20C)$ If $C > 30pF$, $DF \leq 0.1\%$	To satisfy the specified initial spec.	* Preheat 150 to 200 °C for size ≥ 3216 .																															
		I.R.	I.R. $\geq 10,000M\Omega$ or $R_C C_R \geq 500\Omega \cdot F$ (whichever is smaller)	I.R. $\geq 10,000M\Omega$ or $R_C C_R \geq 500\Omega \cdot F$ (whichever is smaller)	*High dielectric constant type: Initial measurement : perform a heat treatment at $150 \pm 0/-10^\circ C$ for one hour and then let sit for 24 ± 2 hours at room temperature. Perform the initial measurement.																															

No	Item	Specification		Test Method	
		Temp. compensation type	High dielectric constant type		
14	Temperature cycle (Thermal shock)	Appearance	No marking defects		Solder the capacitor to supporting jig (Glass epoxy board) and perform the five cycles according to the four heat treatments listed in the following table. Let sit for 24±2hrs at room temperature, then measure. Step 1: Minimum operating temperature 30±3min Step 2: Room temperature 2~3 min Step 3: Maximum operating temperature 30±3min Step 4: Room temperature 2~3min *High dielectric constant type: Initial measurement: perform a heat treatment at 150±10°C for one hour and then let sit for 24±2 hours at room temp. Perform the initial measurement.
		Cap. Change	NP0 within ±2.5% or 0.25pF (whichever is larger)	X5R/X6S/X7R/X7S/X7T/X8R within ±7.5% X7U within ±30%	
		Q/D.F.	If C ≤ 30pF, DF ≤ 1/(400+20C) If C > 30pF, DF ≤ 0.1%	To satisfy the specified initial spec.	
		I.R.	I.R. ≥ 10GΩ or R _C R ≥ 500Ω-F. (whichever is smaller)	I.R. ≥ 10GΩ or R _C R ≥ 500Ω-F. (whichever is smaller)	
15	Humidity load	Appearance	No marking defects		Apply the rated voltage at 40±2°C and 90 to 95% humidity for 500±12 hours. The charge / discharge current is less than 50mA. [Temperature compensation type] Remove and let sit for 24±2 hours at room temperature, then measure. [High dielectric constant type] *Initial measurement Perform a heat treatment at 150+0/-10°C for one hour and then let sit for 24±2 hours at room temperature. Perform the initial measurement. *Measurement after test Perform a heat treatment and then let sit for 24±2 hours at room temperature, then measure.
		Cap. Change	NP0 within ±7.5% or 0.75pF (whichever is larger)	X5R/X6S/X7R/X7S/X7T/X7U/X8R within ±12.5%	
		Q/D.F.	If C > 30pF, DF ≤ 0.5% If C ≤ 30pF, DF ≤ 1/(100+10xC/3) C in pF	X5R/X6S/X7R/X7S/X7T/X7U/X8R 200% max of initial spec..	
		I.R.	I.R. ≥ 500MΩ or R _C R ≥ 25Ω-F. (whichever is smaller)	I.R. ≥ 500MΩ or R _C R ≥ 25Ω-F. (whichever is smaller)	
16	High temperature load life test	Appearance	No marking defects		Apply 200%of the rated voltage for 1000±12 hours at the maximum operating temperature ± 3°C. The charge / discharge current is less than 50mA. [Temperature compensation type] Remove and let sit for 24±2 hours at room temperature, then measure. [High dielectric constant type] *Initial measurement Perform a heat treatment at 150+0/-10°C for one hour and then let sit for 24±2 hours at room temperature. Perform the initial measurement. *Measurement after test Perform a heat treatment and then let sit for 24±2 hours at room temperature, then measure.
		Cap. Change	NP0 within ±7.5% or 0.75pF (whichever is larger)	X5R/X6S/X7R/X7S/X7T/X7U/X8R within ±12.5%	
		Q/D.F.	If C > 30pF, DF ≤ 0.3% If 10pF < C ≤ 30pF, DF ≤ 1/(275+5xC/2) C in pF	X5R/X6S/X7R/X7S/X7T/X7U/X8R 200% max of initial spec.	
		I.R.	More than 1GΩ or R _C R ≥ 50Ω-F (whichever is less.)	More than 1GΩ or R _C R ≥ 50Ω-F (whichever is less.)	

● General Purpose (II)

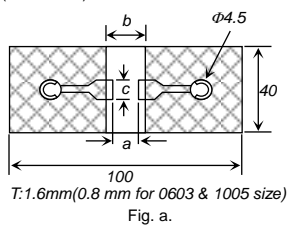
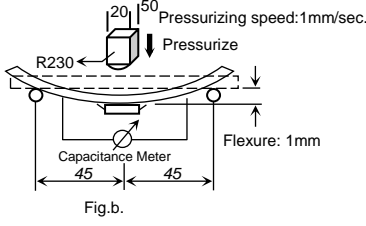
No	Item	Specification	Test Method																																
1	Operation Temperature Range	X5R: -55 to 85 °C X6S/X6T: -55 to 105 °C X7R/X7S/X7T/X7U: -55 to 125 °C X8R: -55 to 150 °C	---																																
2	Rated Voltage	Shown in the table of "Part Number & Characteristic"	The rated voltage is defined as the maximum voltage, which may be applied continuously to the capacitor.																																
3	Appearance	No defects or abnormalities.	Visual inspection																																
4	Dimensions	Within the specified dimension.	Using calipers																																
5	Dielectric Strength	No defects or abnormalities.	No failure shall be observed when 250% of the rated voltage is applied between the terminations for 1 to 5 seconds. The charge and discharge current is less than 50mA.																																
6	Insulation Resistance (I.R.)	R _C R _r ≥ 50Ω-F High cap: <table border="1"> <thead> <tr> <th>Series</th> <th>Cap Range</th> <th>Insulation Resistance</th> </tr> </thead> <tbody> <tr> <td>X5R/X6S X6T/X7R X7S</td> <td>0603 ≥ 2.2uF; 1005 ≥ 22uF 1608 ≥ 47uF; 2012 ≥ 100uF 3216 ≥ 100uF; 3225 ≥ 100uF</td> <td>RiCR ≥ 20Ω-F</td> </tr> </tbody> </table>	Series	Cap Range	Insulation Resistance	X5R/X6S X6T/X7R X7S	0603 ≥ 2.2uF; 1005 ≥ 22uF 1608 ≥ 47uF; 2012 ≥ 100uF 3216 ≥ 100uF; 3225 ≥ 100uF	RiCR ≥ 20Ω-F	The insulation resistance shall be measured with a DC voltage not exceeding the rated voltage at 25°C and 75%RH max, and within 1 minute of charging, provided the charge/discharge current is less than 50 mA.																										
Series	Cap Range	Insulation Resistance																																	
X5R/X6S X6T/X7R X7S	0603 ≥ 2.2uF; 1005 ≥ 22uF 1608 ≥ 47uF; 2012 ≥ 100uF 3216 ≥ 100uF; 3225 ≥ 100uF	RiCR ≥ 20Ω-F																																	
7	Capacitance	Within the specified tolerance * X5R, X6S, X6T, X7R, X7S, X7T, X7U and X8R at 1000 hours High cap: at 24 hours <table border="1"> <thead> <tr> <th>Series</th> <th>Cap Range</th> </tr> </thead> <tbody> <tr> <td>X5R/X6S X6T X7R/X7S</td> <td>0603 ≥ 4.7uF; 1005 ≥ 22uF 1608 ≥ 47F; 2012 ≥ 100uF 3216 ≥ 220F; 3225 ≥ 330uF</td> </tr> </tbody> </table>	Series	Cap Range	X5R/X6S X6T X7R/X7S	0603 ≥ 4.7uF; 1005 ≥ 22uF 1608 ≥ 47F; 2012 ≥ 100uF 3216 ≥ 220F; 3225 ≥ 330uF	The capacitance / D.F. shall be measured at 25°C at the frequency and voltage shown in the table of "Part Number & Characteristic". Heat treatment: Perform a heat treatment at 150+0/-10°C for 1hour and then let sit at room temperature, then measure																												
Series	Cap Range																																		
X5R/X6S X6T X7R/X7S	0603 ≥ 4.7uF; 1005 ≥ 22uF 1608 ≥ 47F; 2012 ≥ 100uF 3216 ≥ 220F; 3225 ≥ 330uF																																		
8	Q/Dissipation Factor (D.F.)	Shown in the table of "Part Number & Characteristic"																																	
9	Capacitance Temperature Characteristics	Capacitance change X5R/X7R/X8R within ±15% , X6S/X7S within ±22% X7U: -56% to + 22% X6T/X7T: -33% to + 22%	The ranges of capacitance change compared with the 25°C value over the temperature ranges shall be within the specified ranges. Measurement Voltage : Less than 1.0Vrms (Refer to the electrical characteristics)																																
10	Termination Strength	No removal of the terminations or marking defect.	Apply a parallel force of 5N to a PCB mounted sample for 10±1sec. *2N for 0603 (EIA 0201).																																
11	Deflection (Bending Strength)	No cracking or marking defects shall occur at 1mm deflection. Capacitance change: X5R, X6S, X6T, X7R, X7S, X7T, X7U, X8R :within ±12.5% (Unit in mm)  <table border="1"> <thead> <tr> <th>Size</th> <th>a</th> <th>b</th> <th>C</th> </tr> </thead> <tbody> <tr> <td>0603</td> <td>0.3</td> <td>0.9</td> <td>0.3</td> </tr> <tr> <td>1005</td> <td>0.4</td> <td>1.5</td> <td>0.5</td> </tr> <tr> <td>1608</td> <td>1.0</td> <td>3.0</td> <td>1.2</td> </tr> <tr> <td>2012</td> <td>1.2</td> <td>4.0</td> <td>1.65</td> </tr> <tr> <td>3216</td> <td>2.2</td> <td>5.0</td> <td>2.0</td> </tr> <tr> <td>4520</td> <td>3.5</td> <td>7.0</td> <td>2.5</td> </tr> <tr> <td>4532</td> <td>3.5</td> <td>7.0</td> <td>3.7</td> </tr> </tbody> </table>  	Size	a	b	C	0603	0.3	0.9	0.3	1005	0.4	1.5	0.5	1608	1.0	3.0	1.2	2012	1.2	4.0	1.65	3216	2.2	5.0	2.0	4520	3.5	7.0	2.5	4532	3.5	7.0	3.7	Solder the capacitor to the test jig (glass epoxy boards) shown in Fig.a using a SAC305(Sn96.5Ag3.0Cu0.5) solder (then let sit for 24±2 hours for X5R, X6S, X7R, X7S, X7T, X7U and X8R). Then apply a force in the direction shown in Fig.b. The soldering shall be done with the reflow method and shall be conducted with care so that the soldering is uniform and free of defects such as heat shock.
Size	a	b	C																																
0603	0.3	0.9	0.3																																
1005	0.4	1.5	0.5																																
1608	1.0	3.0	1.2																																
2012	1.2	4.0	1.65																																
3216	2.2	5.0	2.0																																
4520	3.5	7.0	2.5																																
4532	3.5	7.0	3.7																																
12	Solderability of Termination	90% of the terminations are to be soldered evenly and continuously.	Immerse the test capacitor into a methanol solution containing rosin for 3 to 5 seconds, preheat it 150 to 180°C for 2 to 3 minutes and immerse it into SAC305(Sn96.5Ag3.0Cu0.5) solder of 245 ± 5°C for 3±1seconds.																																
13	Resistance to Soldering Heat	<table border="1"> <thead> <tr> <th>Appearance</th> <td>No marking defects</td> </tr> <tr> <th>Cap. Change</th> <td>X5R/X6S/X6T/X7R/X7S/X7T/X7U/X8R within ±7.5%</td> </tr> <tr> <th>D.F.</th> <td>To satisfy the specified initial spec.</td> </tr> </thead> </table> <table border="1"> <thead> <tr> <th>I.R.</th> <td>R_CR_r ≥ 50Ω-F. High cap: <table border="1"> <thead> <tr> <th>Series</th> <th>Cap Range</th> <th>Insulation Resistance</th> </tr> </thead> <tbody> <tr> <td>X5R/X6S X6T/X7R X7S</td> <td>0603 ≥ 2.2uF; 1005 ≥ 22uF 1608 ≥ 47uF; 2012 ≥ 100uF 3216 ≥ 100uF; 3225 ≥ 100uF</td> <td>RiCR ≥ 20Ω-F</td> </tr> </tbody> </table> </td> </tr> </thead> </table>	Appearance	No marking defects	Cap. Change	X5R/X6S/X6T/X7R/X7S/X7T/X7U/X8R within ±7.5%	D.F.	To satisfy the specified initial spec.	I.R.	R _C R _r ≥ 50Ω-F. High cap: <table border="1"> <thead> <tr> <th>Series</th> <th>Cap Range</th> <th>Insulation Resistance</th> </tr> </thead> <tbody> <tr> <td>X5R/X6S X6T/X7R X7S</td> <td>0603 ≥ 2.2uF; 1005 ≥ 22uF 1608 ≥ 47uF; 2012 ≥ 100uF 3216 ≥ 100uF; 3225 ≥ 100uF</td> <td>RiCR ≥ 20Ω-F</td> </tr> </tbody> </table>	Series	Cap Range	Insulation Resistance	X5R/X6S X6T/X7R X7S	0603 ≥ 2.2uF; 1005 ≥ 22uF 1608 ≥ 47uF; 2012 ≥ 100uF 3216 ≥ 100uF; 3225 ≥ 100uF	RiCR ≥ 20Ω-F	*Preheat the capacitor at 120 to 150°C for 1 minute. Immerse the capacitor in a SAC305(Sn96.5Ag3.0Cu0.5) solder solution at 270±5°C for 10±1 seconds. Let sit at room temperature for 24±2 hours, then measure. * Preheat 150 to 200°C for size ≥ 3216. * Initial measurement : perform a heat treatment at 150+0/-10°C for one hour and then let sit for 24±2 hours at room temperature. Perform the initial measurement.																		
Appearance	No marking defects																																		
Cap. Change	X5R/X6S/X6T/X7R/X7S/X7T/X7U/X8R within ±7.5%																																		
D.F.	To satisfy the specified initial spec.																																		
I.R.	R _C R _r ≥ 50Ω-F. High cap: <table border="1"> <thead> <tr> <th>Series</th> <th>Cap Range</th> <th>Insulation Resistance</th> </tr> </thead> <tbody> <tr> <td>X5R/X6S X6T/X7R X7S</td> <td>0603 ≥ 2.2uF; 1005 ≥ 22uF 1608 ≥ 47uF; 2012 ≥ 100uF 3216 ≥ 100uF; 3225 ≥ 100uF</td> <td>RiCR ≥ 20Ω-F</td> </tr> </tbody> </table>	Series	Cap Range	Insulation Resistance	X5R/X6S X6T/X7R X7S	0603 ≥ 2.2uF; 1005 ≥ 22uF 1608 ≥ 47uF; 2012 ≥ 100uF 3216 ≥ 100uF; 3225 ≥ 100uF	RiCR ≥ 20Ω-F																												
Series	Cap Range	Insulation Resistance																																	
X5R/X6S X6T/X7R X7S	0603 ≥ 2.2uF; 1005 ≥ 22uF 1608 ≥ 47uF; 2012 ≥ 100uF 3216 ≥ 100uF; 3225 ≥ 100uF	RiCR ≥ 20Ω-F																																	

No	Item	Specification	Test Method
14	Temperature cycle (Thermal shock)	Appearance	Solder the capacitor to supporting jig (Glass epoxy board) and perform the five cycles according to the four heat treatments listed in the following table. Let sit for 24±2hrs at room temperature, then measure. Step 1: Minimum operating temperature 30±3min Step 2: Room temperature 2-3 min Step 3: Maximum operating temperature 30±3min Step 4: Room temperature 2-3min * Initial measurement: perform a heat treatment at 150±10°C for one hour and then let sit for 24±2 hours at room temp. Perform the initial measurement.
		Cap. Change	
		Q/D.F.	
		I.R.	
15	Humidity load	Appearance	Apply the rated voltage at 40±2°C and 90 to 95% humidity for 500±12 hours. The charge / discharge current is less than 50mA. *Initial measurement Perform a heat treatment at 150+0/-10°C for one hour and then let sit for 24±2 hours at room temperature. Perform the initial measurement. *Measurement after test Perform a heat treatment and then let sit for 24±2 hours at room temperature, then measure.
		Cap. Change	
		Q/D.F.	
		I.R.	
16	High temperature load life test	Appearance	Apply 150% of the rated voltage for 1000±12 hours at the maximum operating temperature ± 3°C. The charge / discharge current is less than 50mA. *Initial measurement Perform a heat treatment at 150+0/-10°C for one hour and then let sit for 24±2 hours at room temperature. Perform the initial measurement. *Measurement after test Perform a heat treatment and then let sit for 24±2 hours at room temperature, then measure. * Some of the parts are applicable in rated voltage *100%. Please refer to "Part Number & Characteristic" with (II)* labeled in "Test Spec."
		Cap. Change	
		D.F.	
		I.R.	

Package

- Tape and reel packaging**

Tape and reel packaging is currently the most promising system for high-speed production. A typical 180mm (7 inch) diameter reel contains 1,500 to 15,000 capacitors, 250mm (10 inch) contains 10,000 capacitors, and 330mm (13 inch) contains 10,000 to 50,000 capacitors. Three standard sizes are available in taped and reeled package either with paper carrier tapes or embossed tapes.

【Paper tape specifications】

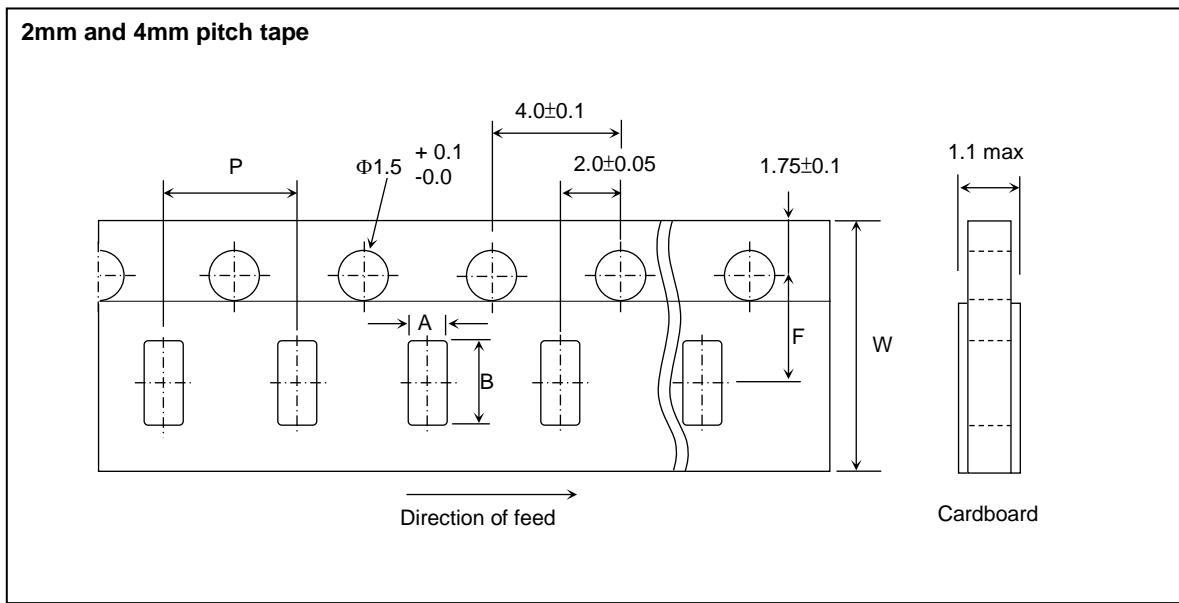

SYMBOL	PRODUCT SIZE CODE												UNIT
	C0603(0201)		C1005(0402) Standard		C1005(0402) Special (1)		C1005(0402) Special (2)		C1005(0402) Special (3)		C1005(0402) Special (4)		
	SIZE	TOL.	SIZE	TOL.	SIZE	TOL.	SIZE	TOL.	SIZE	TOL.	SIZE	TOL.	
A	0.38	± 0.04	0.65	± 0.10	0.70	± 0.10	0.72	± 0.10	0.80	± 0.10	0.90	± 0.10	mm
B	0.68	± 0.04	1.15	± 0.10	1.19	± 0.10	1.25	± 0.10	1.35	± 0.10	1.45	± 0.10	mm
F	3.5	± 0.05	3.5	± 0.05	3.5	± 0.05	3.5	± 0.05	3.5	± 0.05	3.5	± 0.05	mm
P	2	± 0.10	2	± 0.10	2	± 0.10	2	± 0.10	2	± 0.10	2	± 0.10	mm
W	8	± 0.20	8	± 0.20	8	± 0.20	8	± 0.20	8	± 0.20	8	± 0.20	mm

SYMBOL	PRODUCT SIZE CODE (EIA)										UNIT
	C1608(0603) Standard		C1608 (0603) Special (1)		C1608 (0603) Special (2/3)		C2012 (0805)		C3216 (1206)		
	SIZE	TOL.	SIZE	TOL.	SIZE	TOL.	SIZE	TOL.	SIZE	TOL.	
A	1.0	±0.2	1.0	±0.2	1.1	±0.2	1.5	±0.2	1.9	±0.2	mm
B	1.8	±0.2	1.8	±0.2	1.9	±0.2	2.3	±0.2	3.6	±0.2	mm
F	3.5	±0.05	3.5	±0.05	3.5	±0.05	3.5	±0.05	3.5	±0.05	mm
P	4	±0.1	4	±0.1	4	±0.1	4	±0.1	4	±0.1	mm
W	8	±0.2	8	±0.2	8	±0.2	8	±0.2	8	±0.2	mm

【 Embossed tape specifications 】

1mm and 4mm and 8mm pitch tape

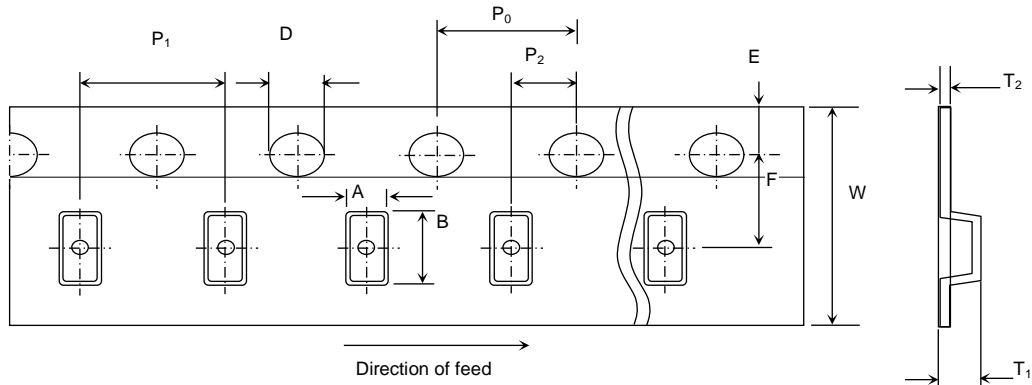

DIMENSION (mm)	PRODUCT SIZE CODE					
	1608 (0603)	2012 (0805)	3216 (1206)	3225 (1210)	4520 (1808)	4532 (1812)
P_1	4±0.1	4±0.1	4±0.1	4±0.1	4±0.1	8±0.1
P_0	4±0.1	4±0.1	4±0.1	4±0.1	4±0.1	4±0.1
P_2	2±0.05	2±0.05	2±0.05	2±0.05	2±0.05	2±0.05
A	1.2±0.2	1.45±0.2	1.9±0.2	2.8±0.2	2.3±0.2	3.6±0.2
B	2.0±0.2	2.3±0.2	3.5±0.2	3.6±0.2	4.9±0.2	4.9±0.2
W	8±0.3	8±0.2	8±0.2	8±0.2	12±0.2	12±0.2
E	1.75±0.1	1.75±0.1	1.75±0.1	1.75±0.1	1.75±0.1	1.75±0.1
F	3.5±0.05	3.5±0.05	3.5±0.05	3.5±0.05	5.5±0.05	5.5±0.05
D	1.5 (+0.1/-0.0)	1.5 (+0.1/-0.0)	1.5 (+0.1/-0.0)	1.5 (+0.1/-0.0)	1.5 (+0.1/-0.0)	1.5 (+0.1/-0.0)
T_1	1.4 max.	2.0 max.	2.2 max.	3.0 max.	2.5 max.	4.5 max.
T_2	0.25±0.1	0.30±0.1	0.30±0.1	0.30±0.1	0.30±0.1	0.30±0.1

【Reel specifications】

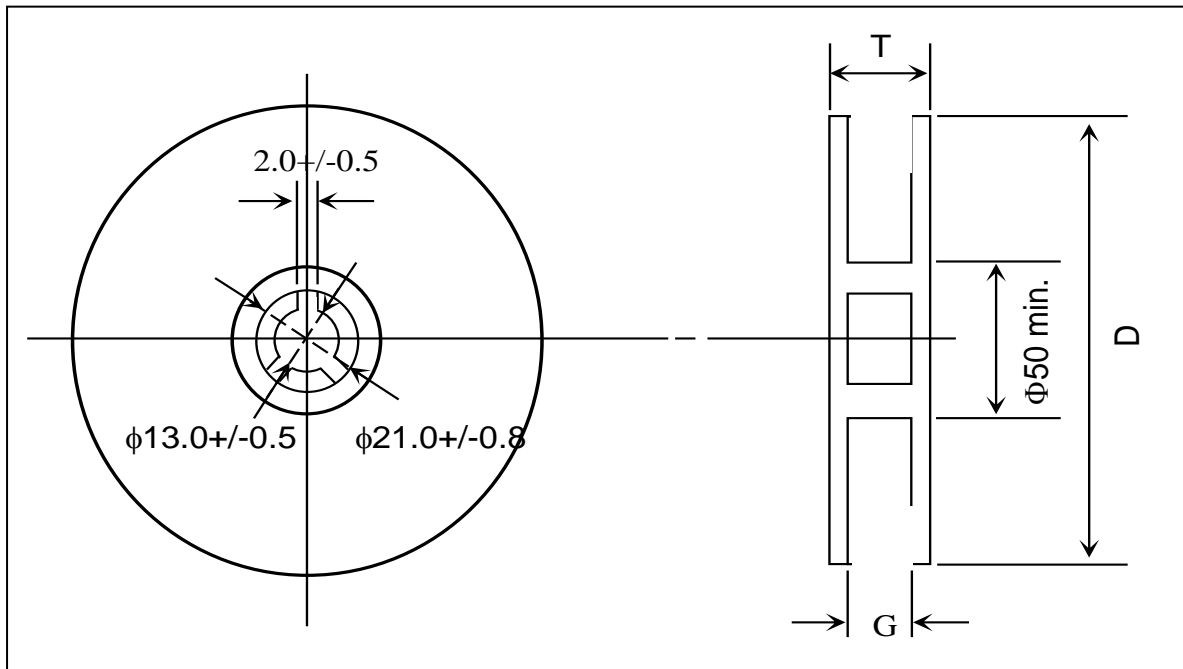

TAPE WIDTH (mm)	G (mm)	T max. (mm)	D (mm)
4	5.0 ± 1.5	8.0	180
8	10.0 ± 1.5	14.5	180
8	10.0 ± 1.5	14.5	250
8	10.0 ± 1.5	14.5	330
12	14.0 ± 1.5	18.5	180

【Thickness and Packing Amount】

Thickness			Amount per reel			
Code	Spec.(mm)	Size (EIA)	180 mm (7")		330 mm (13")	
			Paper	Embossed	Paper	Embossed
Z	0.20	0402 (01005)	20K	40K ^{#1}		
A	0.30	0603 (0201)	15K		50K	
		1005 (0402)	15K		50K	
B	0.50	1005 (0402)	10K		50K	
Q	0.45	1005 (0402)	10K		50K	
		1608 (0603)	4K		15K	
C	0.60	2012 (0805)	4K		15K	
		3216 (1206)	4K		15K	
D	0.80	1608 (0603)	4K	4K	15K	
		2012 (0805)	4K		15K	
		3216 (1206)	4K		15K	
E	0.85	2012 (0805)	4K		15K	
		3216 (1206)	4K		15K	
		3225 (1210)		3K		10K
I	0.95	4532 (1812)		1K		
		2012 (0805)		3K		
F	1.15	3216 (1206)		3K		
		4520 (1808)		3K		10K
G	1.25	3216 (1206)		3K		10K
		4520 (1808)		2K/3K		10K
		4532 (1812)		1K		
		3225 (1210)		3K		
		3216 (1206)		2K		
		3225 (1210)		2K		
L	1.60	4520 (1808)		2K		
		4532 (1812)		1K		
		3216 (1206)		2K/3K		
N	2.00	3225 (1210)		1K/2K		
		4520 (1808)		1K/2K		
		4532 (1812)		1K		
P	2.50	3225 (1210)		500pcs/1K		

#1: 4mm width 1mm pitch Embossed Taping

【Packing Rule】

EIA SIZE	Tape type	Reel Size	Max Reels/Box
0402 (01005)	Emboss	7"	16
0402 (01005)	Paper	7"	10
0603 (0201)	Paper	7"	10
1005 (0402)	Paper	7"	10
1608 (0603)	Paper/Emboss	7"	10
2012 (0805)	Paper/Emboss	7"	10
3216 (1206)	Paper/Emboss	7"	10
3225 (1210)	Emboss	7"	10
4520 (1808)	Emboss	7"	10
4532 (1812)	Emboss	7"	10

*Maximum 60 reels in one carton.

Others

【Storage】

1. The chip capacitors shall be packaged in carrier tapes or bulk cases.
2. Keep storage place temperatures from +5°C to +35°C, humidity from 45 to 70% RH.
3. The storage atmosphere must be free of gas containing sulfur and chlorine. Also, avoid exposing the product to saline moisture. If the product is exposed to such atmospheres, the terminations will oxidize and solderability will be affected.
4. The solderability is assured for 12 months from our final inspection date if the above storage condition is followed.

【Circuit Design】

1. Once application and assembly environments have been checked, the capacitor may be used in conformance with the rating and performance, which are provided in both the catalog and the specifications. Exceeding the specifications listed may result in inferior performance. It may also cause a short, open, smoking, or flaming to occur, etc.
2. Please use the capacitors in conformance with the operating temperature provided in both the catalog and the specifications. Be especially cautious not to exceed the maximum temperature. In the situation the maximum temperature set forth in both the catalog and specifications is exceeded, the capacitor's insulation resistance may deteriorate, power may suddenly surge and short-circuit may occur. The loss of capacitance will occur, and may self-heat due to equivalent series resistance when alternating electric current is passed through. As this effect becomes critical in high frequency circuits, please exercise with caution. When using the capacitor in a (self-heating) circuit, please make sure the surface of the capacitor remains under the maximum temperature for usage. Also, please make certain temperature rise remain below 20°C.
3. Please keep voltage under the rated voltage, which is applied to the capacitor. Also, please make certain the peak voltage remains below the rated voltage when AC voltage is super-imposed to the DC voltage. In the situation where AC or pulse voltage is employed, ensure average peak voltage does not exceed the rated voltage. Exceeding the rated voltage provided in both catalog and specifications may lead to defective withstanding voltage or, in worse case situations, may cause the capacitor to burn out.
4. It's is a common phenomenon of high-dielectric products to have a deteriorated amount of static electricity due to the application of DC voltage.

【Handling】

Chip capacitors should be handled with care to avoid contamination or damage. The use of vacuum pick-up or plastic tweezers is recommended for manual placement. Tape and reeled packages are suitable for automatic pick and placement machine.

【Flux】

1. An excessive amount of flux or too rapid temperature rise can causes solvent burst, solder can generate a large quantity of gas. The gas can spreads small solder particles to cause solder balling effect or bridging problem.
2. Flux containing too high of a percentage of halide may cause corrosion of termination unless sufficient cleaning is applied.
3. Use rosin-type flux. Highly acidic flux (halide content less than 0.2wt%) is not recommended.
4. The water soluble flux causes deteriorated insulation resistance between outer terminations unless sufficiently cleaned.

【Component Spacing】

For wave soldering components, the spacing must be sufficient far apart to prevent bridging or shadowing. This is not so important for reflow process but enough space for rework should be considered. The suggested spacing for reflow soldering and wave soldering is 0.5mm and 1.0mm, respectively.

【Solder Fillet】

Too much solder amount may increase solder stress and cause crack risk. Insufficient solder amount may reduce adhesive Strength and cause parts falling off PCB. When soldering, confirm that the solder is placed over 0.2mm of the surface of the terminations.

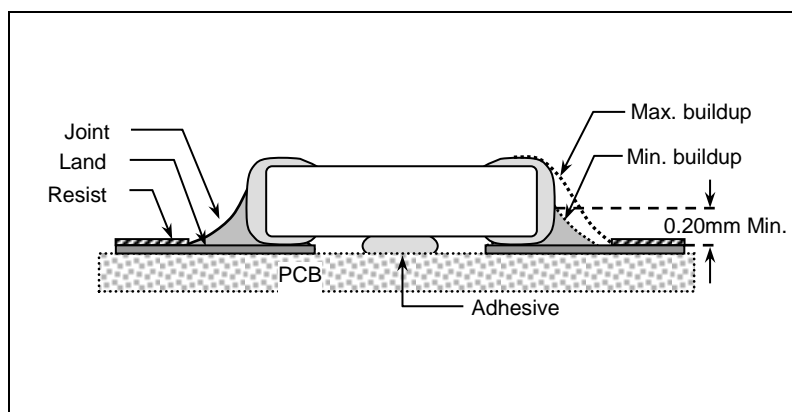

【Recommended Land Pattern Dimensions】

When mounting the capacitor to substrate, it's important to consider that the amount of solder (size of fillet) used has a direct effect upon the capacitor once it's mounted.

1. The greater the amount of solder, the greater the stress to the elements, as this may cause the substrate to break or crack.
2. In the situation where two or more devices are mounted onto a common land, separate the device into exclusive pads by using soldering resist.
3. Land width equal to or less than component. It is permissible to reduce land width to 80% of component width.

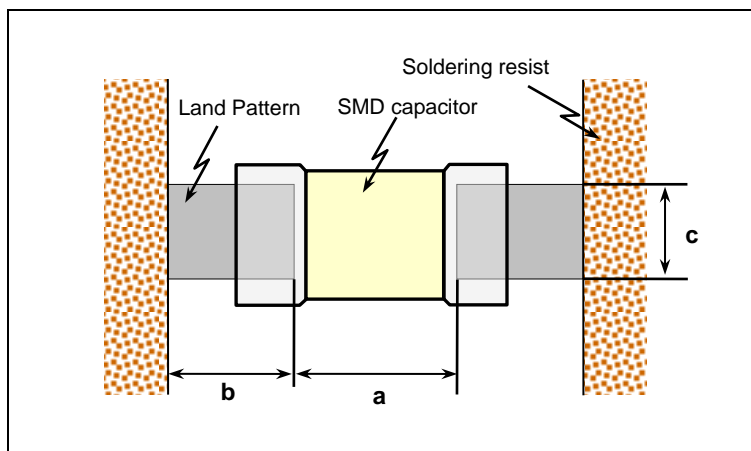

Size mm (EIA)	L x W (mm) (Dimension tolerance)	a (mm)	b (mm)	c (mm)
0402 (01005)	0.4*0.2	0.16 to 0.20	0.12 to 0.18	0.20 to 0.23
0603 (0201)	0.6*0.3 (within±0.03)	0.2 to 0.35	0.2 to 0.3	0.2 to 0.4
	0.6*0.3 (±0.05/±0.09)	0.2 to 0.35	0.2 to 0.35	0.25 to 0.4
1005 (0402)	1.0*0.5 (within±0.10)	0.3 to 0.5	0.35 to 0.45	0.4 to 0.6
	1.0*0.5 (±0.15/±0.20)	0.4 to 0.6	0.4 to 0.5	0.5 to 0.7
1608 (0603)	1.6*0.8 (within±0.10)	0.7 to 1.0	0.6 to 0.8	0.7 to 0.8
	1.6*0.8 (±0.15/±0.20/±0.25)	0.8 to 1.1	0.7 to 0.8	0.8 to 1.0
2012 (0805)	2.0*1.25	1.0 to 1.4	0.7 to 0.9	1.2 to 1.4
3216 (1206)	3.2*1.6 (within±0.20)	1.8 to 2.4	0.9 to 1.2	1.5 to 1.9
	3.2*1.6 (within±0.30)	1.9 to 2.5	1.0 to 1.3	1.7 to 2.0
3225 (1210)	3.2*2.5	1.8 to 2.5	1.0 to 1.2	2.0 to 2.5
4520 (1808)	4.5*2.0	3.2 to 3.8	1.2 to 1.4	1.7 to 2.0
4532 (1812)	4.5*3.2	3.0 to 3.5	1.4 to 1.6	2.7 to 3.5

[Resin Mold]

If a large amount of resin is used for molding the chip, cracks may occur due to contraction stress during curing. To avoid such cracks, use a low shrinkage resin. The insulation resistance of the chip will degrade due to moisture absorption. Use a low moisture absorption resin. Check carefully that the resin does not generate a decomposition gas or reaction gas during the curing process or during normal storage. Such gases may crack the chip capacitor or damage the device itself.

[Soldering Profile for SMT Process with SnPb Solder Paste]

Reflow Soldering

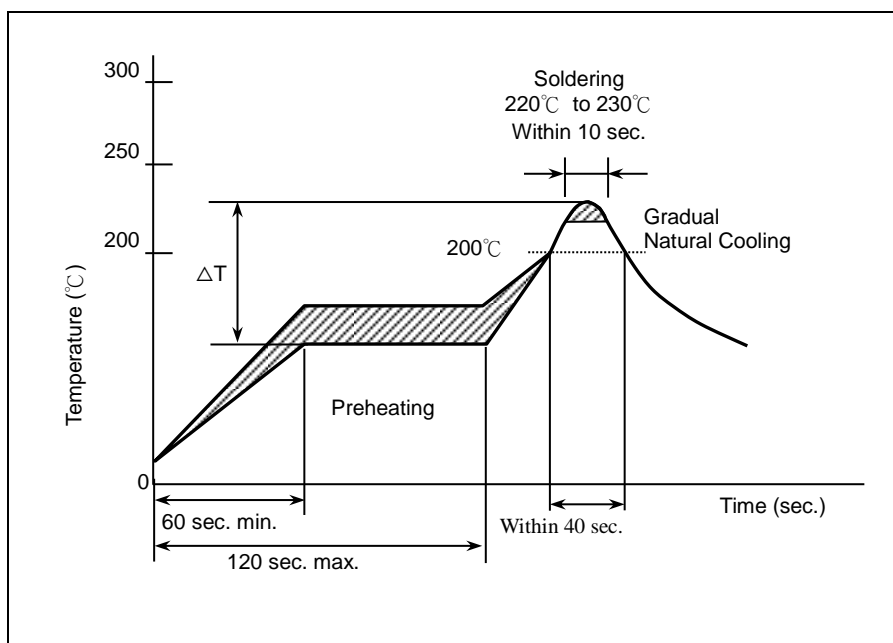

The difference between solder and chip surface should be controlled as following table. The rate of preheat should not exceed 4°C/sec and a target of 2°C/sec is preferred.

Chip Size	3216 and smaller	3225 and above
Preheating	$\Delta T \leq 150^{\circ}\text{C}$	$\Delta T \leq 130^{\circ}\text{C}$

MLCC

Wave Soldering

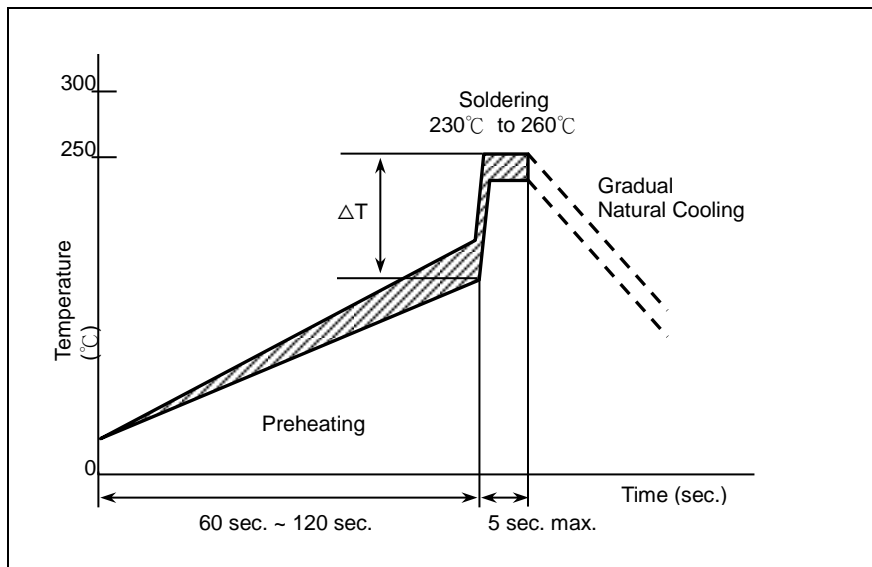

Chip Size	1608/2012/3216	3225 and above
Preheating	$\Delta T \leq 150^\circ\text{C}$	-

Soldering Iron

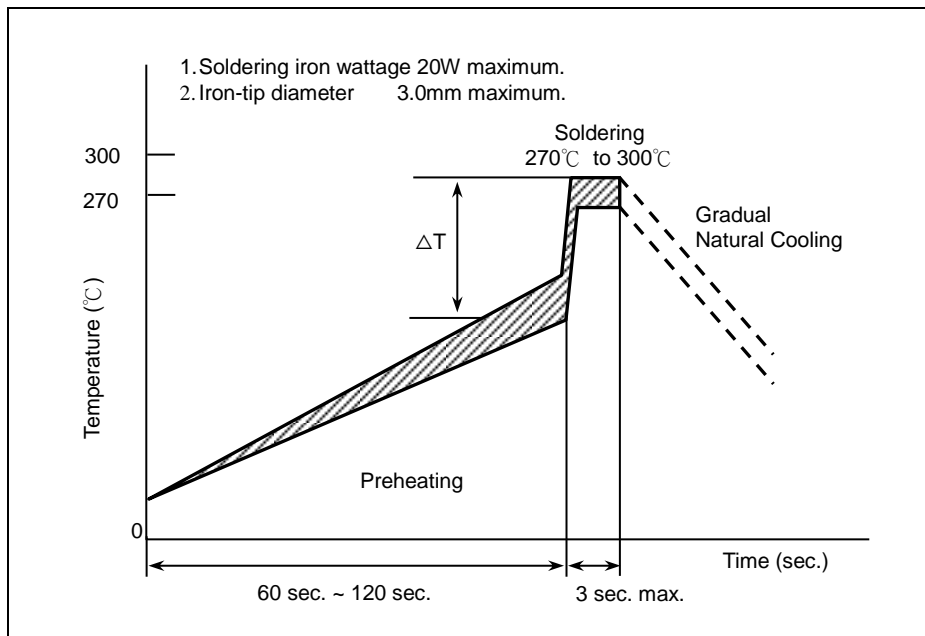

Chip Size	3216 and smaller	3225 and above
Preheating	$\Delta T \leq 190^\circ\text{C}$	$\Delta T \leq 130^\circ\text{C}$

[Soldering]

Reflow Soldering for Lead free Termination

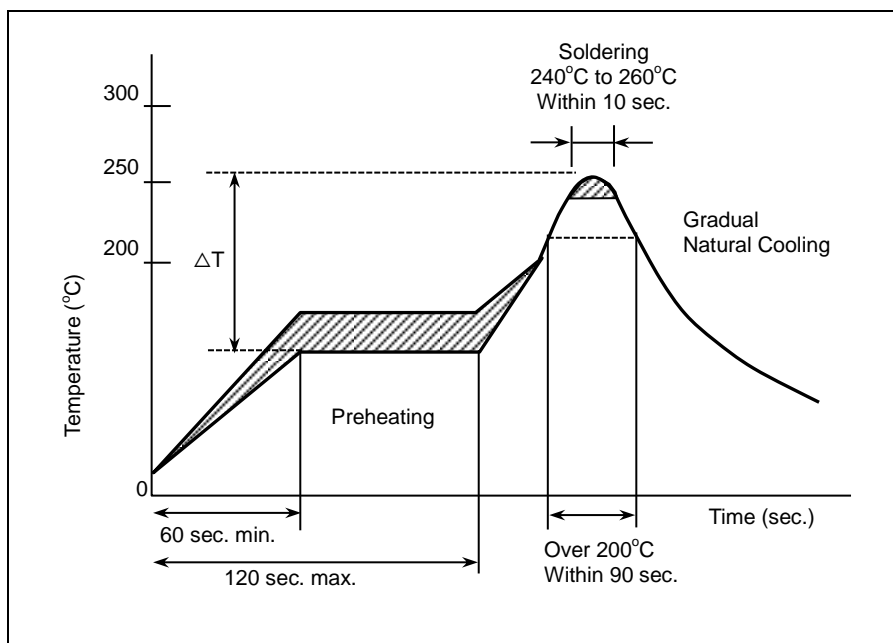

The difference between solder and chip surface should be controlled as following table. The rate of preheat should not exceed 4°C/sec and a target of 2°C/sec is preferred.

Chip Size	3216 and smaller	3225 and above
Preheating	$\Delta T \leq 150^\circ\text{C}$	$\Delta T \leq 130^\circ\text{C}$

Flow Soldering for Lead free Termination

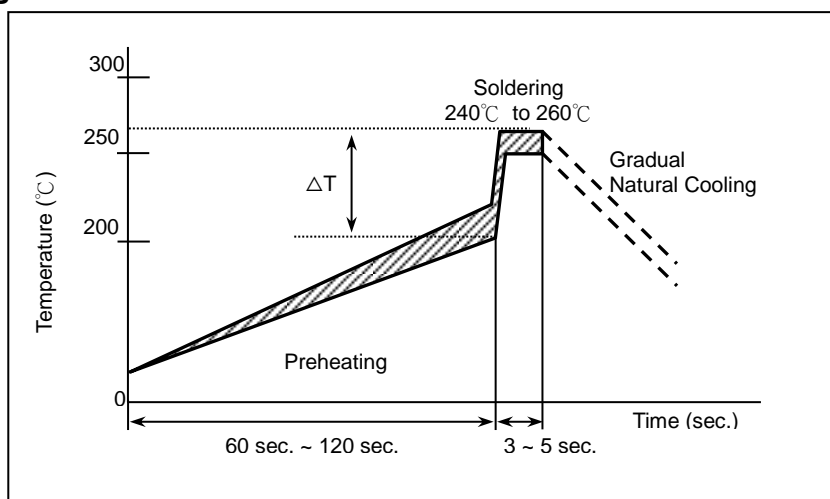

Chip Size	1608/2012/3216	3225 and above
Preheating	$\Delta T \leq 150^\circ\text{C}$	-

Soldering Iron

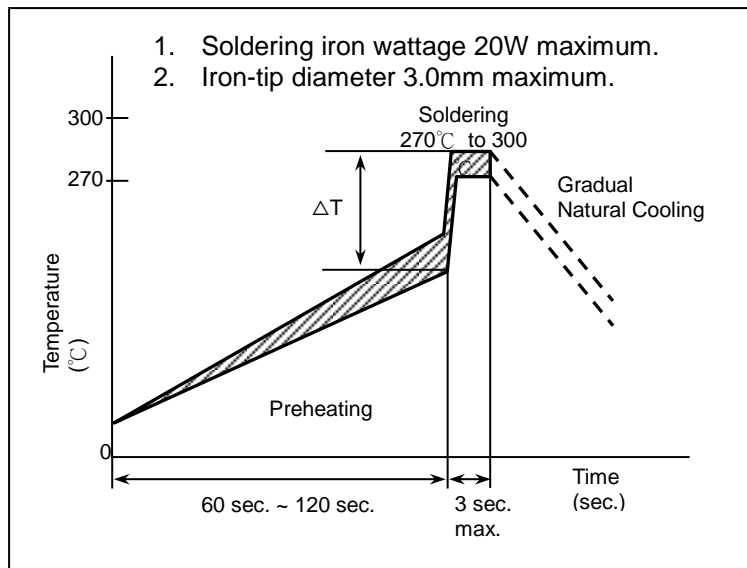

Chip Size	3216 and smaller	3225 and above
Preheating	$\Delta T \leq 190^\circ\text{C}$	$\Delta T \leq 130^\circ\text{C}$

【Chip Layout and Breaking PCB】

- To layout the SMD capacitors for reducing bend stress from board deflection of PCB. The following are examples of Hood and bad layout.

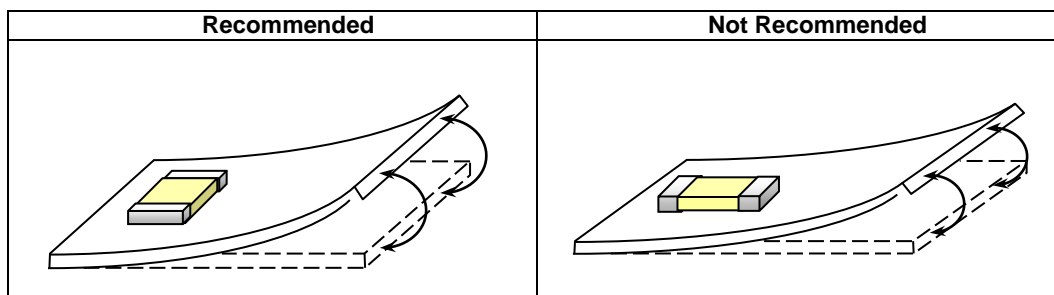

- When breaking PCB, the layout should be noted that the mechanical stresses are depending on the position of capacitors. The following example shows recommendation for better design.

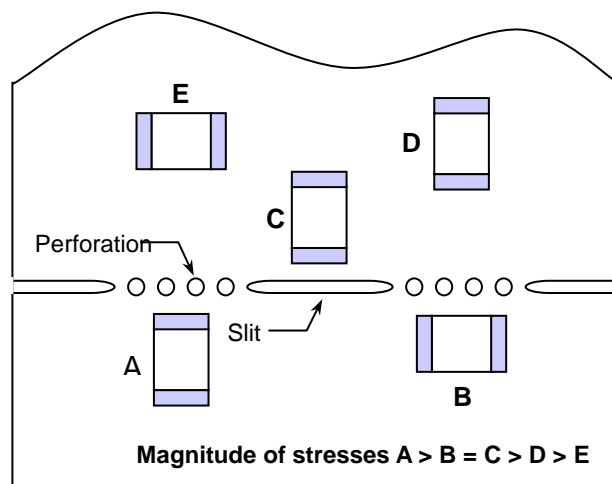

【Temperature Coefficient】

- Class 1 (Temperature Compensation series)

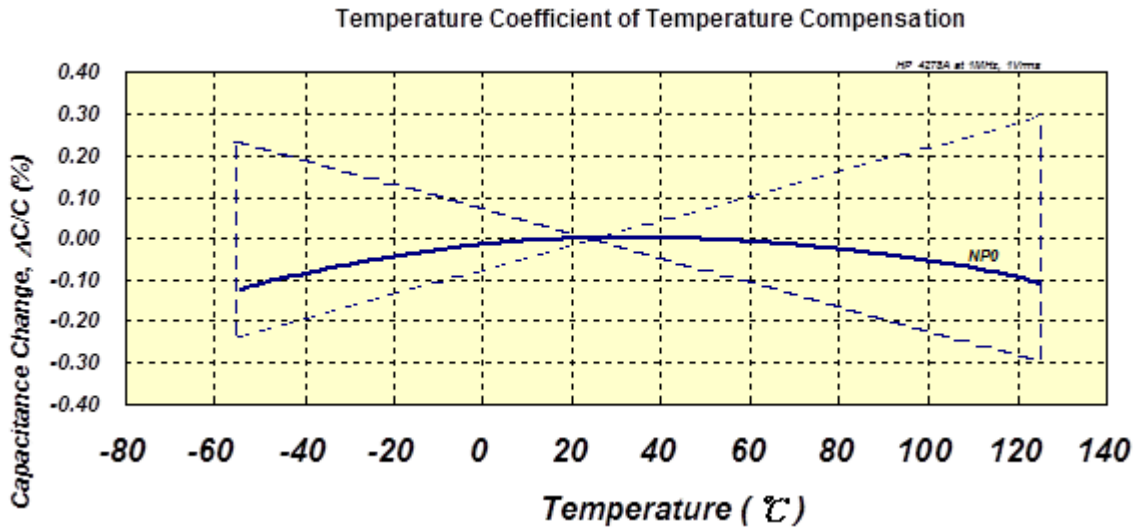

- Class 2 (High Dielectric Constant Series)

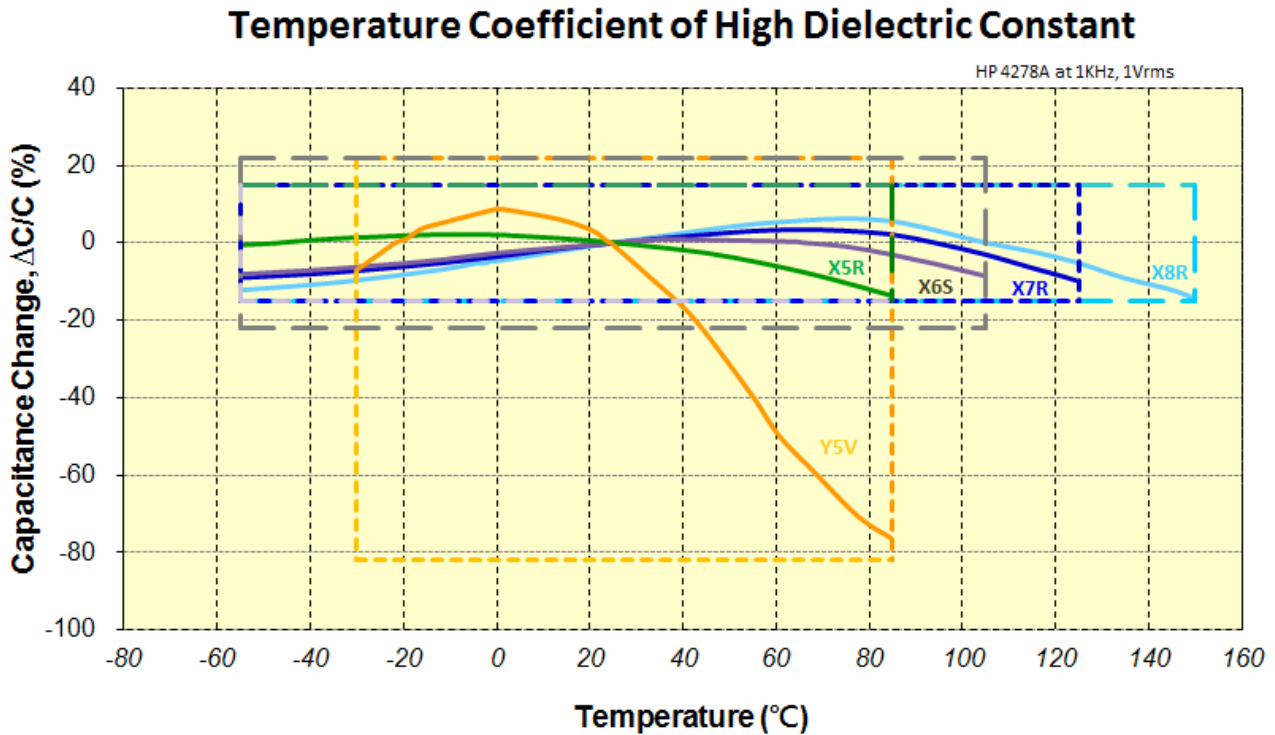

MLCC

[DC Voltage Coefficient]

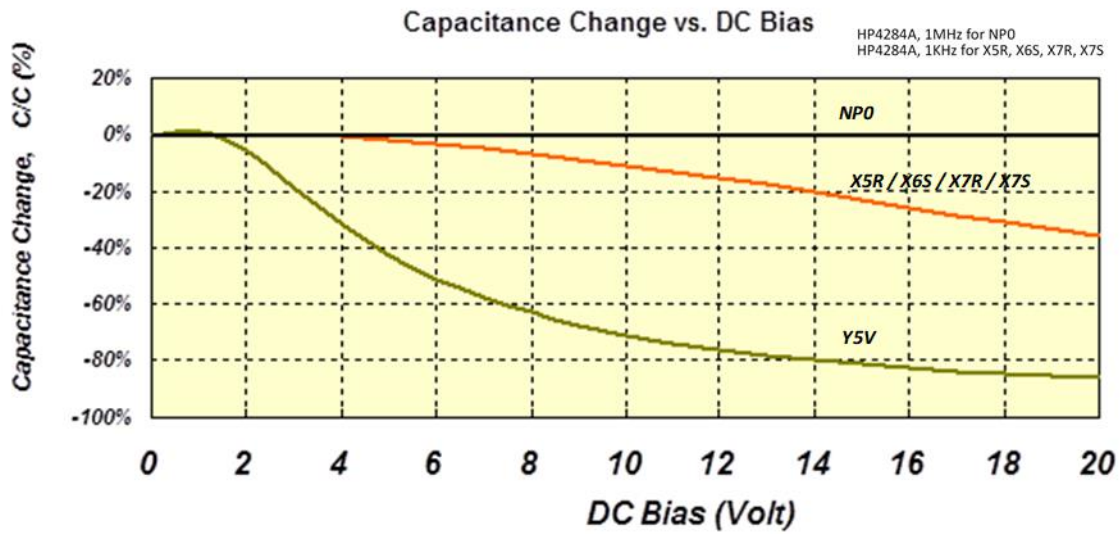

[Aging Rate]

The capacitance and dissipation factor of class 2 capacitors decreases with time. It is known as 'aging' that follows a logarithmic law and expressed in terms of an aging constant. Aging is caused by a gradual re-alignment of the crystalline structure of the ceramic. The aging constant is defined as the percentage loss of capacitance at a 'time decade'. The law of capacitance aging is expressed as following equation:

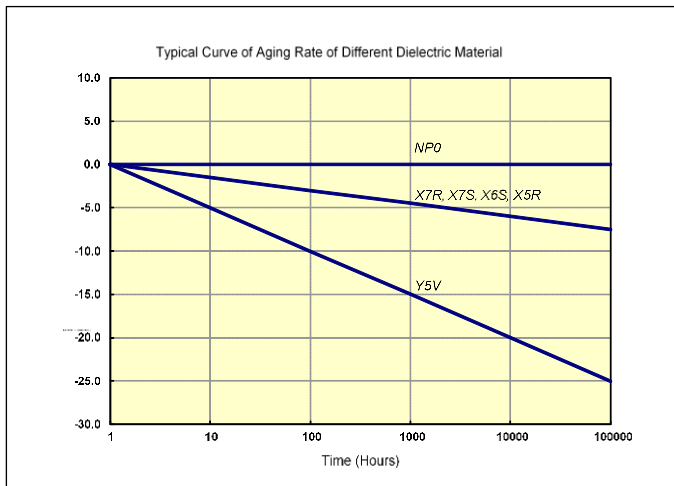

$$C_{t2} = C_{t1} \times (1 - k \times \log_{10}(t_2/t_1))$$

C_{t1} : Capacitance after t_1 hours of start aging.

C_{t2} : Capacitance after t_2 hours of start aging.

k : aging constant (capacitance decrease per decade)

t_1, t_2 : time in hours from start of aging.

A typical curve of aging rate is shown in following figure.

When heating the capacitors above Curie temperature (130°C~150°C) the capacitance can be re-new. So capacitance of class 2 capacitors will be complete de-aged by soldering process; subsequently a new aging process begins.

Because of aging, it is specified an age for measurement to meet the prescribed tolerance for class 2 capacitors. Normally, 1000 hours ($t_2=1000$ hrs) is defined.

【Voltage Derating & Applied Voltage】

The derated MLCC should be applied with the derating voltage. The “Temperature of MLCC” is the surface temperature of MLCC including self-heating effect. The maximum operating voltage of MLCC with reference to the maximum voltage (Vmax) is as shown in the following graph.

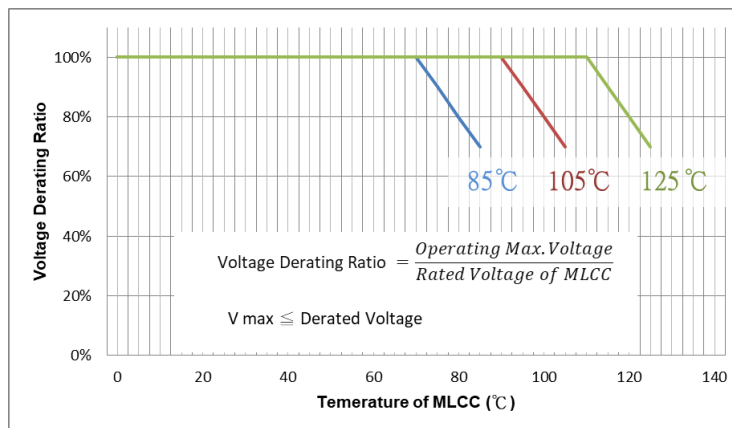

Cautions by types of voltage applied to MLCC - For DC voltage or DC+AC voltage, DC voltage or the maximum value of DC + AC voltage should not exceed the rated voltage of MLCC. - For AC voltage or pulse voltage, the peak-to-peak value of AC voltage or pulse voltage should not exceed the rated voltage of MLCC. - Abnormal voltage such as surge voltage, static electricity should not exceed the rated voltage of MLCC.

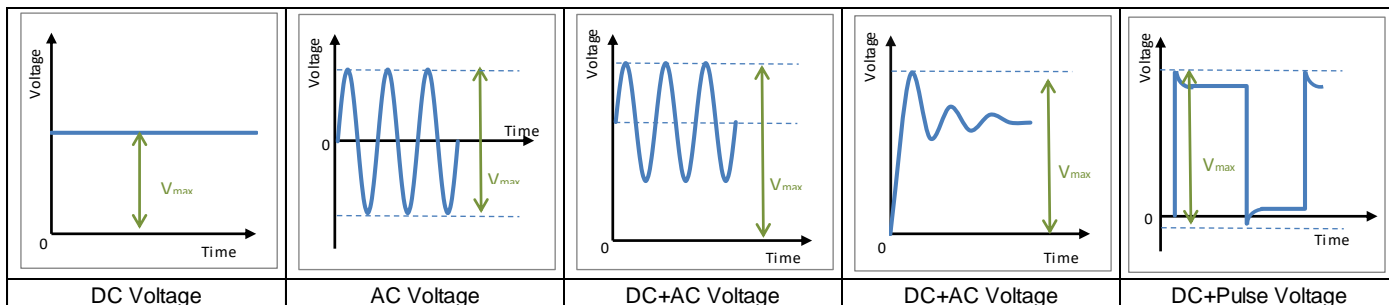

【Peeling Off Force】

Peeling off force: 0.1N to 1.0 N* in the direction shown as below.

The peeling speed: 300±10 mm/min

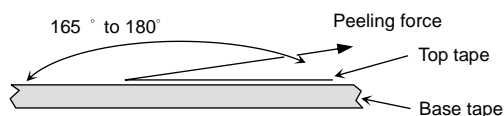

1. The taped tape on reel is wound clockwise. The sprocket holes are to the right as the tape is pulled toward the user.
2. There are minimum 150 mm as the leader and minimum 40 mm empty tape as the tail is attached to the end of the tape.