

SPECIFICATION DATA SHEET

DATE: 29-Oct-10

TYPE	HC-49US/SMD
Part Number	AS49SD-25M-FE120E2
Nominal frequency	25.000000 MHz
Oscillation mode	Fundamental
Frequency tolerance	± 30 ppm 25±3°C
Temperature characteristics	± 30 ppm (-10°C ~+ 70°C)
Load capacitance	12.0 pF
Drive level	100 μW
Series capacitance (C ₁)	— fF
Parallel capacitance (C ₀)	7.0 pF Max
Series resistance	30 Ω Max
Storage Temperature	-40°C ~+ 85°C
Aging	± 3 ppm Max /Year

OUTLINE DIMENSIONS

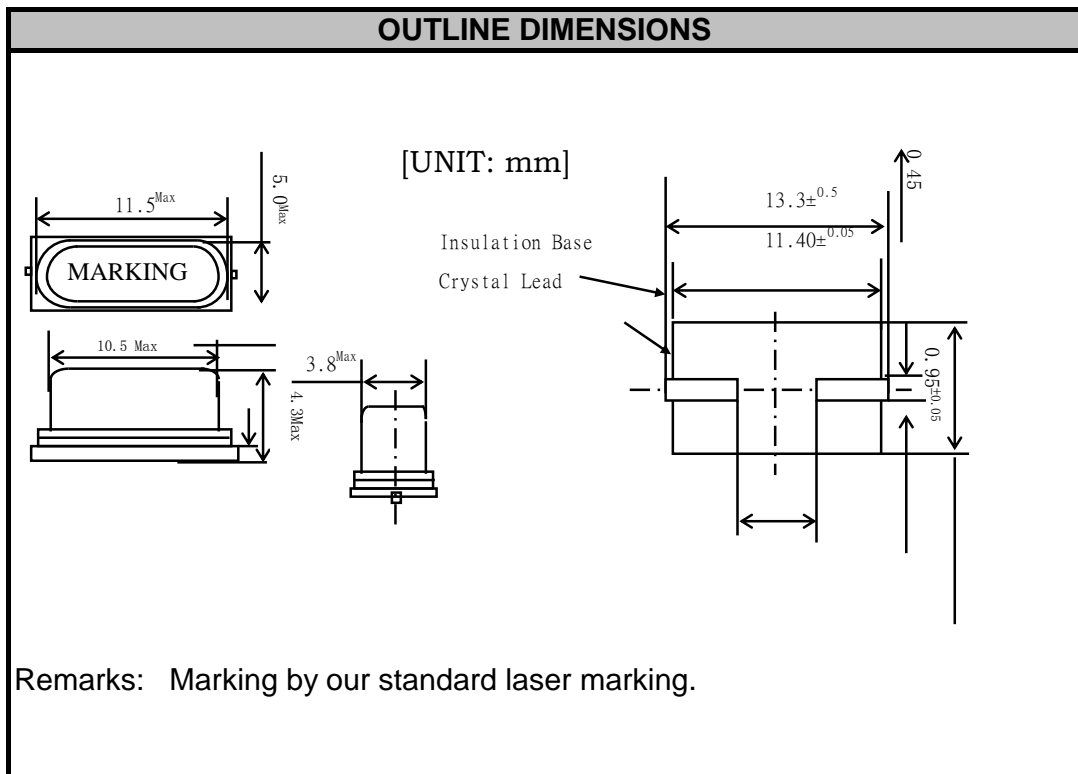

* We reserved the right to change the content anytime.