

SWISSDIS



Swissdis AG
Grasweg 7
CH-4911 Schwarzhäusern

Tel.: +41 62 919 44 00
Fax: +41 62 919 44 01
info@swissdis.ch
www.swissdis.ch



SPECIFICATIONS

US1206G LED Chip 1206 Green

Version März 2021

Unilite Opto Technology

email: info@unilite-tech.com

U-S1206G



■ Description

The SMD type U-S1206G, 1 chips Pure Green LED, with its light weight and smaller than lead frame type components, enables smaller board size, higher packing density, reduced storage space and miniature applications.

- Dice Material : InGaP
- Light Color : Pure Green
- Lens Color : Water Clear

■ Features

- 1 chips package
- Compatible with automatic placement equipment
- Compatible with reflow soldering process
- Long operating life
- Low forward voltage operated
- Instant light
- Pb -free/ RoHS compliant
- 3K/ Reel

■ Applications

- Information boards
- Automotive Interior Lighting
- Indoor and outdoor display
- Indicator
- Back Lighting
- General applications

Unilite Opto Technology

email: info@unilite-tech.com

U-S1206G

■ Outline Dimensions (mm)

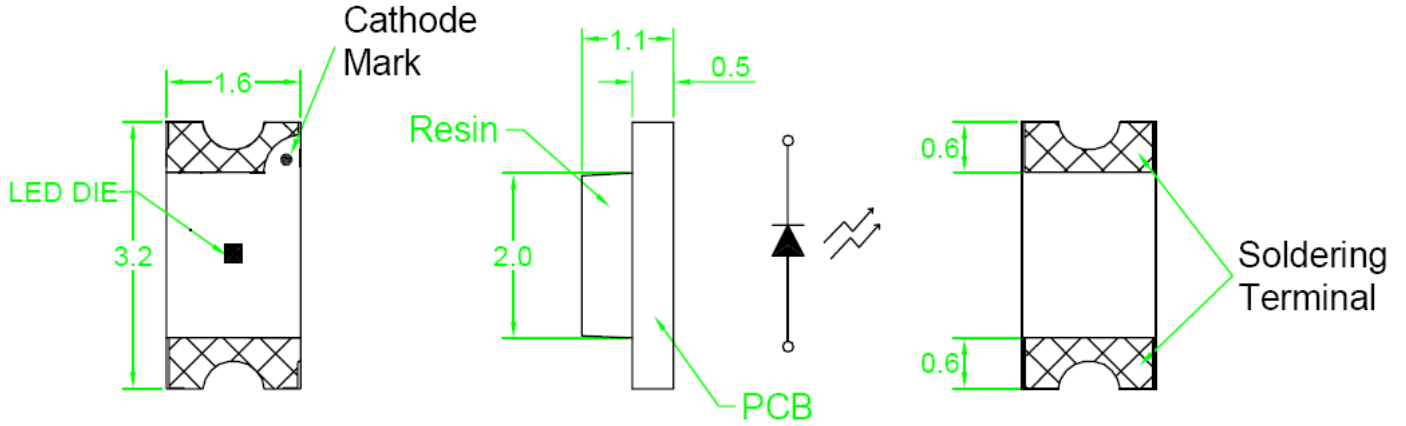

Tolerance : ± 0.1 mm

■ Recommend Soldering Pattern

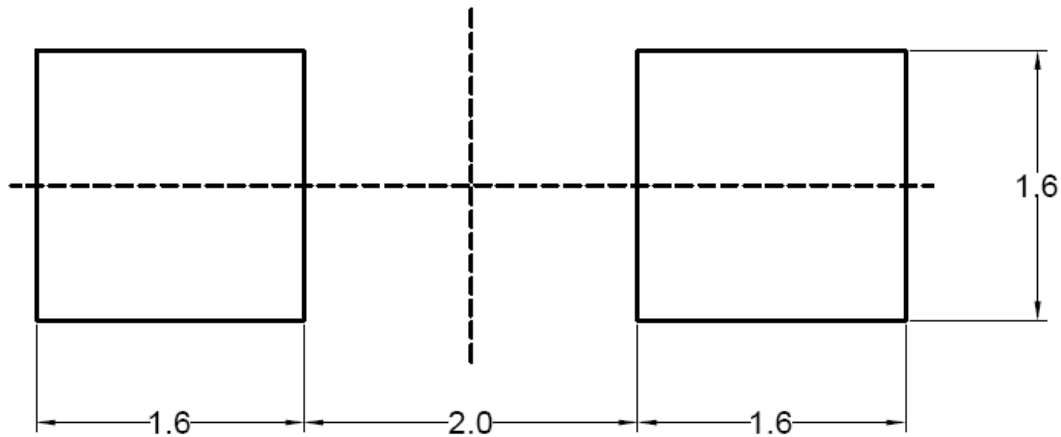

■ Part Numbering System

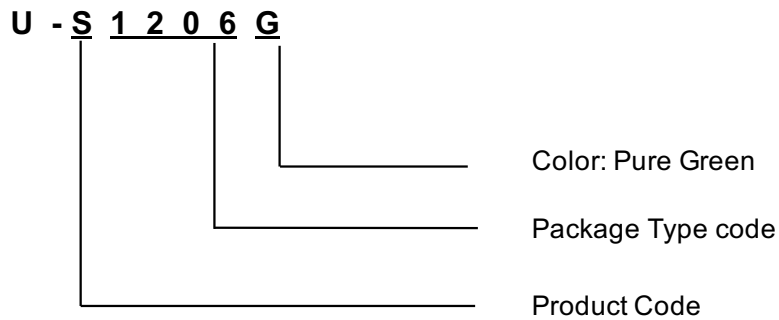

Unilite Opto Technology

email: info@unilite-tech.com

U-S1206G

■ Absolute Maximum Ratings at Ta = 25 °C

PARAMETER	symbol	MAX.	UNIT
Power Dissipation *	PD	72	mW
Continuous Forward Current *	IF	20	mA
Peak Forward Current (1/10 Duty Cycle , 0.1ms Pulse Width) *	IFP	100	mA
Reverse Current@5V	IR	50	μA
Electrostatic Discharge	ESD	500	V
Operating Temperature Range	Topr	-40 to + 85	°C
Storage Temperature Range	Tstg	-40 to + 100	°C

■ Electro-Optical Characteristics

Red ,Ta = 25°C,

PARAMETER	SYMBOL	Symbol	VALUES			UNIT
			MIN.	TYP.	MAX.	
Luminous Intensity	IV	20mA	200	500		mcd
Forward Voltage	Vf	20mA	2.8		3.6	V
View angle	2θ 1/2	20mA		140		Deg
Peak Wavelength	λP	20mA		530		nm
Dominant Wavelength	λd	20mA		525		nm
Spectral Line Half-Width	Δd	20mA		36		nm
Reverse Current, VR= 5V	IR	5V			50	μA

Unilite Opto Technology

email: info@unilite-tech.com

U-S1206G

■ Bin Grade Limits ($I_F = 20 \text{ mA}^*$) Luminous Intensity / mcd

Item		Min	Max	Unit
Luminous Intensity	G1	200	320	mcd
	G2	320	500	mcd
	G3	500	800	mcd
	G4	800	1250	mcd

Tolerance : $\pm 15\%$

■ Bin Grade Limits ($I_F = 20 \text{ mA}$) Wavelength / nm

Bin Code	Min	Max	Unit
GW1	519	522	nm
GW2	522	525	nm
GW3	525	528	nm
GW4	528	531	nm

Unilite Opto Technology

email: info@unilite-tech.com

U-S1206G

■ Typical Electro-Optical Characteristics Curve

Fig.1 Forward current vs. Forward Voltage

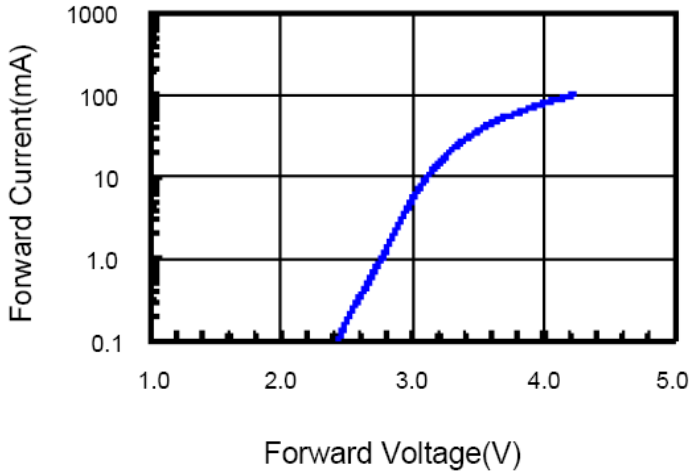

Fig.2 Relative Intensity vs. Forward Current

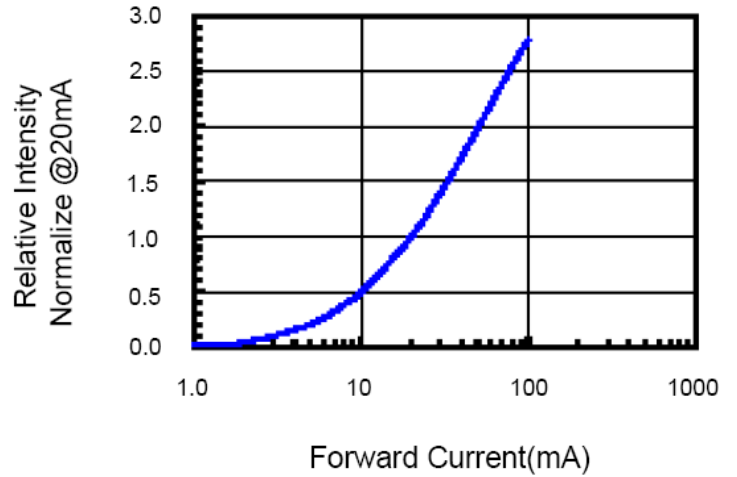

Fig.3 Forward Voltage vs. Temperature

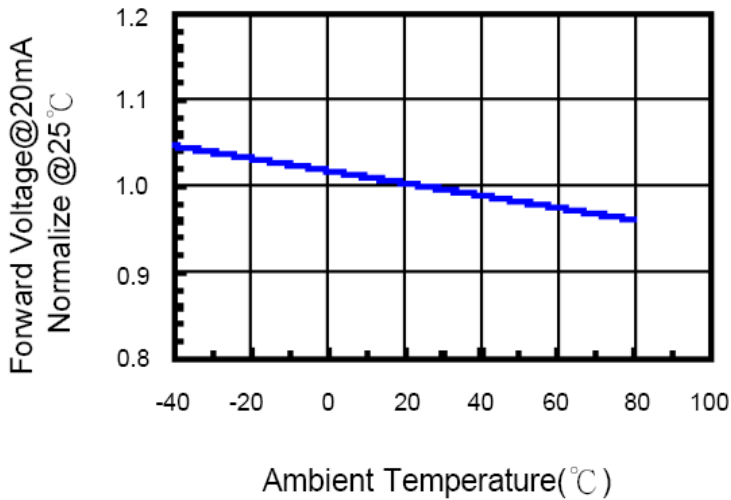
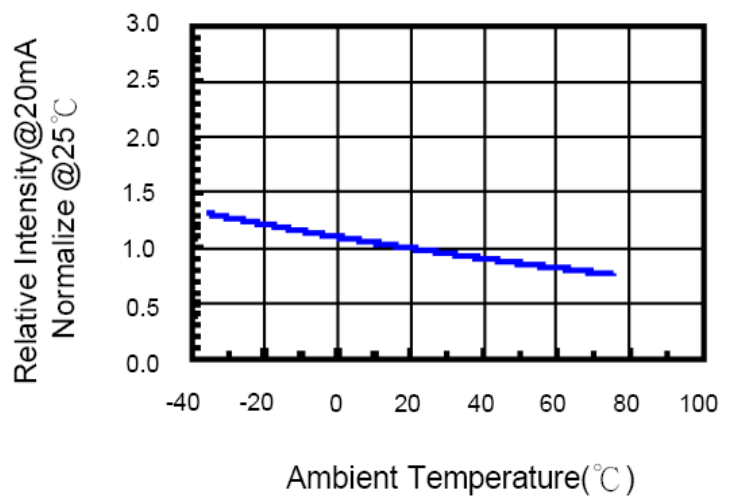

Fig.4 Relative Intensity vs. Temperature



Unilite Opto Technology

email: info@unilite-tech.com

U-S1206G

■ Typical Electro-Optical Characteristics Curve

Fig.5 Relative Intensity vs. Wavelength

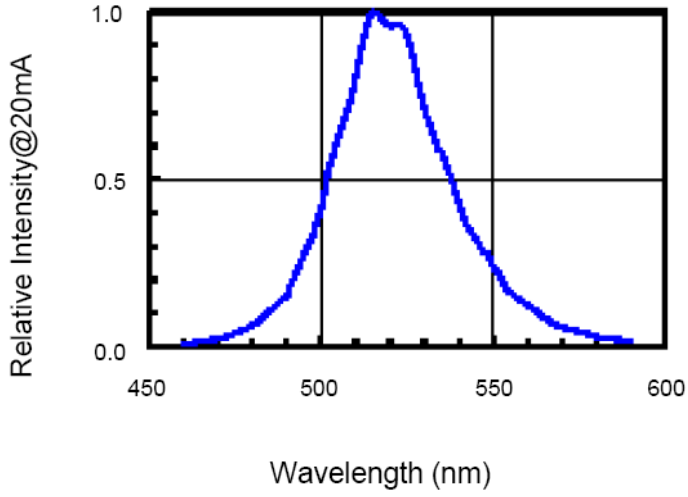
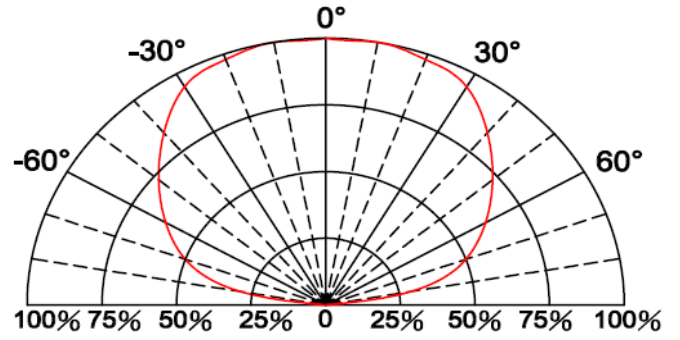

Fig.6 Directive Radiation



Unilite Opto Technology

email: info@unilite-tech.com

U-S1206G

■ Carrier Type Dimensions

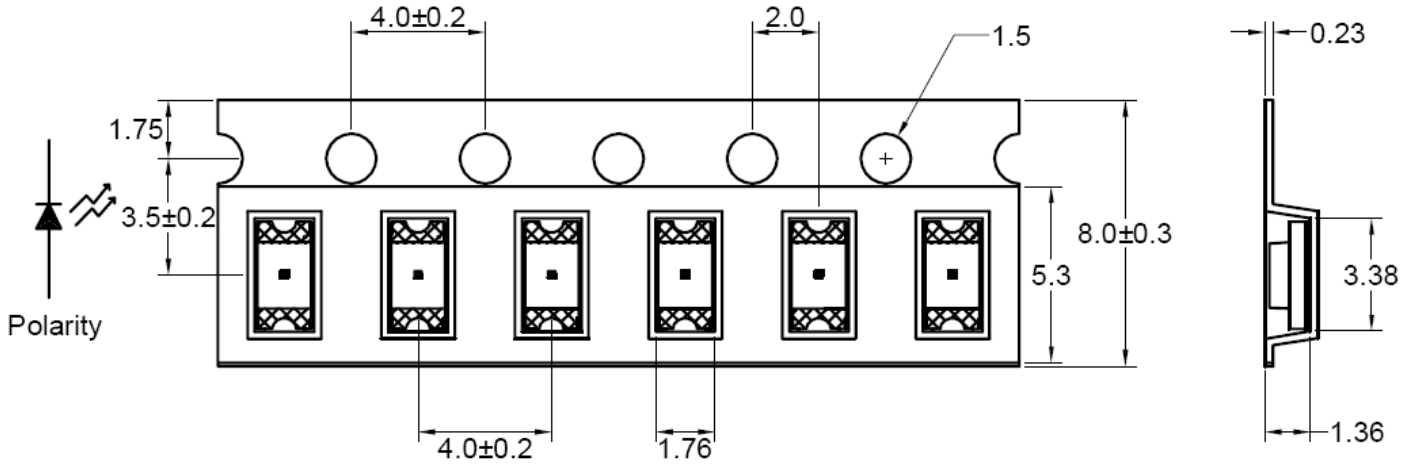

■ Reel Dimensions

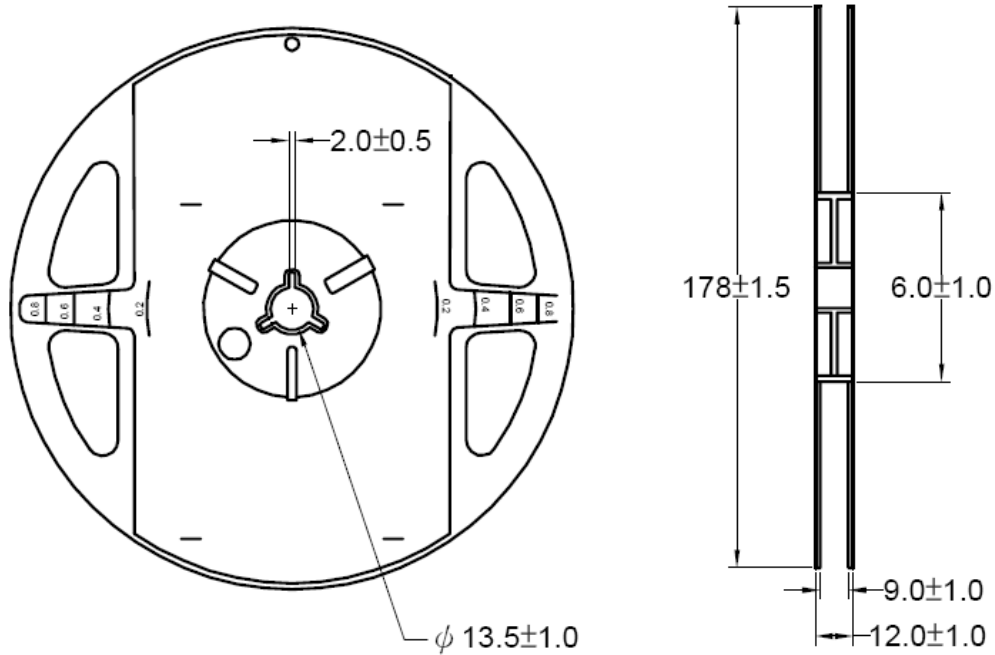

Unilite Opto Technology

email: info@unilite-tech.com

U-S1206G

■ Reliability Test Items and Conditions

(1)TEST ITEMS AND RESULTS

Test Item	Standard Test Method	Test Conditions	Note	Number of Damaged
Thermal Shock	MIL-ST-202F:107D	-40°C ~ 105°C 10min. 10min.	100 cycles	0/20
	MIL-ST-750D:1051			
	MIL-ST-883D:1011			
Temperature Cycle	MIL-ST-202F:107D	105°C ~ 25°C ~ -55°C ~ 25°C 30min. 5min. 30min. 5min.	10 cycles	0/76
	MIL-ST-750D:1051			
	MIL-ST-883D:1010			
	JIS C 7021:A-4			
High Temperature Storage	MIL-STD-883D:1008	Ta=105°C +/- 5°C	1000 hrs.	0/40
	JIS C 7021:B-10			
Low Temperature Storage	JIS C 7021:B-12	Ta=-40°C +/-5°C	1000 hrs.	0/40
Steady State Operating Life	MIL-STD-750D:1026	Ta=25°C, I _F =20mA, DC	1000 hrs.	0/20
	MIL-STD-883D:1005			
	JIS C 7021:B-1			
High Temperature &High Humidity Storage Test	MIL-ST-202F:103B	Ta=65°C +/- 5°C, RH=90-95%,	1000 hrs.	0/40
	JIS C 7021:B-11			
Solerability Test	MIL-ST-202F:208D	T. Sol:235°C +/- 5°C	10 cycles	0/20
	MIL-STD-750D:2026	Immersion Time 2 +/- 0.5sec		
	MIL-STD-883D:2003	Coverage ≥ 95% of the dipped surface		
	IEC 68 Part 2-20			
	JIS C 7021:A-2			
IR Reflow	MIL-STD-750D:2031.2	T=260C Max, 10 sec Max,		
	J-STD-020	Time= 6min		

Unilite Opto Technology

email: info@unilite-tech.com

U-S1206G

■ Cautions

(1) Moisture Proof Package

- A) The moisture proof package, a plastic bag with a zipper, is used to keep moisture to a minimum in the package.
- B) A package of a moisture absorbent material (silica gel) is also inserted into the plastic moisture proof bag and the silica gel changes its color from blue to pink as it absorbs moisture.
- C) The absorbed moisture in the SMT package may vaporize and expand during soldering. This may cause exfoliation of the contacts and damage to the optical characteristics of the LEDs.

(2) Storage Conditions

- A) Before opening the package :
The LEDs should be kept at 30°C or less and 45~60% RH or less and should be used within a year. When storing the LEDs, moisture proof package with absorbent material (silica gel) is recommended.
- B) After opening the package :
The LEDs should be kept at 30°C or less and 55% RH or less and should be soldered within 168 hours (7days) after opening the package. The unused LEDs should be stored in moisture proof packages.
- C) It's also recommended to return the LEDs to the original moisture proof bag and to reseal the moisture proof bag again.
- D) If the moisture absorbent material (silica gel) has faded away or the SMD LEDs have exceeded the storage time, baking treatment (more than 24 hours at 65+/-5°C) should be performed before soldering.

(3) Heat Generation

- A) The thermal design of the end product is very important. It is necessary to avoid intense heat generation and operate within the maximum ratings given in this specification.
- B) The operating current should be decided after considering the ambient maximum temperature of LEDs.

(4) Cleaning

- A) Isopropyl alcohol is recommended to be used as a solvent for cleaning the LEDs.
- B) Before cleaning, a pre-test should be done to confirm whether any damage to the LEDs will occur.

Unilite Opto Technology

email: info@unilite-tech.com

U-S1206G

(5) Soldering

Reflow Soldering (recommended) :

- A) To prevent from cracking, please bake (65°C, 24hrs) before soldering.
- B) When soldering, do not load stress on the LEDs during heating.
- C) Never take next process until the component is cooled down to room temperature after reflow.
- D) After soldering, do not warp the circuit board.
- E) The recommended reflow soldering profile (measuring on the surface of the LED resin) is the following:

(a) Lead-Free Solder

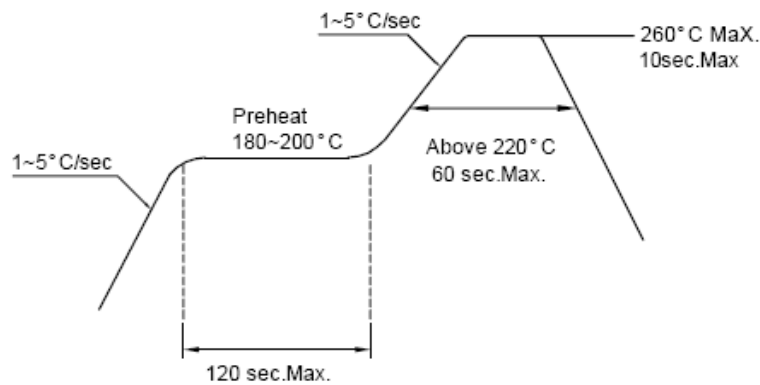

(b) Lead Solder

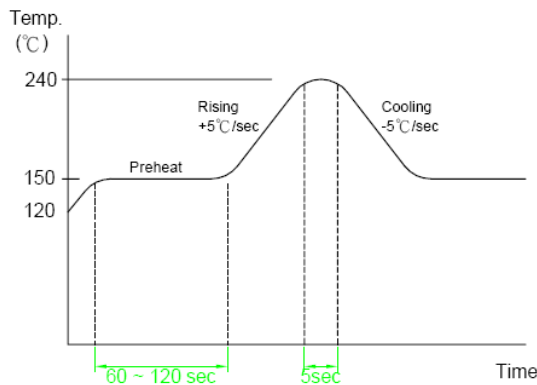

Manual Soldering (not recommended) :

- A) To prevent from cracking, please bake (65°C, 24hrs) before soldering.
- B) Temperature at tip of iron: 250°C Max. (25W).
- C) It's banned to load any stress on the resin during soldering.
- D) Soldering time: 3 sec. Max.(one time only).

Unilite Opto Technology

email: info@unilite-tech.com

U-S1206G

- (6) ESD (eletrostatic discharge) protection (base on machine mode)
- A) The product is Gallium Nitride (GaN) based light emitting diode (LED) and is extremely sensitive to ESD. Users are strongly recommended to take necessary meter to test the static electricy and avoid ESD when handling this product.
 - B) Proper grounding of machines (via $1M\Omega$), using static disspative mats, containers, working uniforms and shoes are considered to be effective against ESD.
 - C) An ionizer is recommended in the facility or environment where ESD may be generated easily, and soldering iron with a grounded tip is also recommended.
 - D) When inspecting the final products in which LEDs are assembled, it is recommended to check whether the assembled LEDs are damaged by ESD or not. It is simple to find damaged LEDs by light-on or VF test at lower current (below 1mA is recommended).
 - E) ESD damaged LEDs will show some unusual characteristics such as the remarkable increasing of leak current, the decreasing of forward voltage, or the LEDs do not light on at the low current.
- (7) Other
- A) Care must be taken to ensure that the reverse voltage will not exceed the absolute maximum rating when using the LEDs with matrix drive.
 - B) The LED light output is strong enough to injure human eyes. Precaution must be taken to prevent looking directly at the LEDs with unaided eyes for more than a few seconds.
 - C) The LEDs described here are intended to be used for ordinary electronic equipment, please consult Unilite Opto in advance for information on applications.
 - D) Installing a protection device in the LED driving circuit to avoid surge current exceeding the max rating during on/off switching.
 - E) The appearance and specifications of the product may be modified for improvement without notice.
 - F) Please use the product within 168 hours after opening the seal and keep under 30 °C and 70% humidity.
 - G) Unilite Opto Technology will not be responsible for any claim for damage if the user use the product without following the caution or instruction of the specification.